

LPC3250 Developer's Kit User's Guide

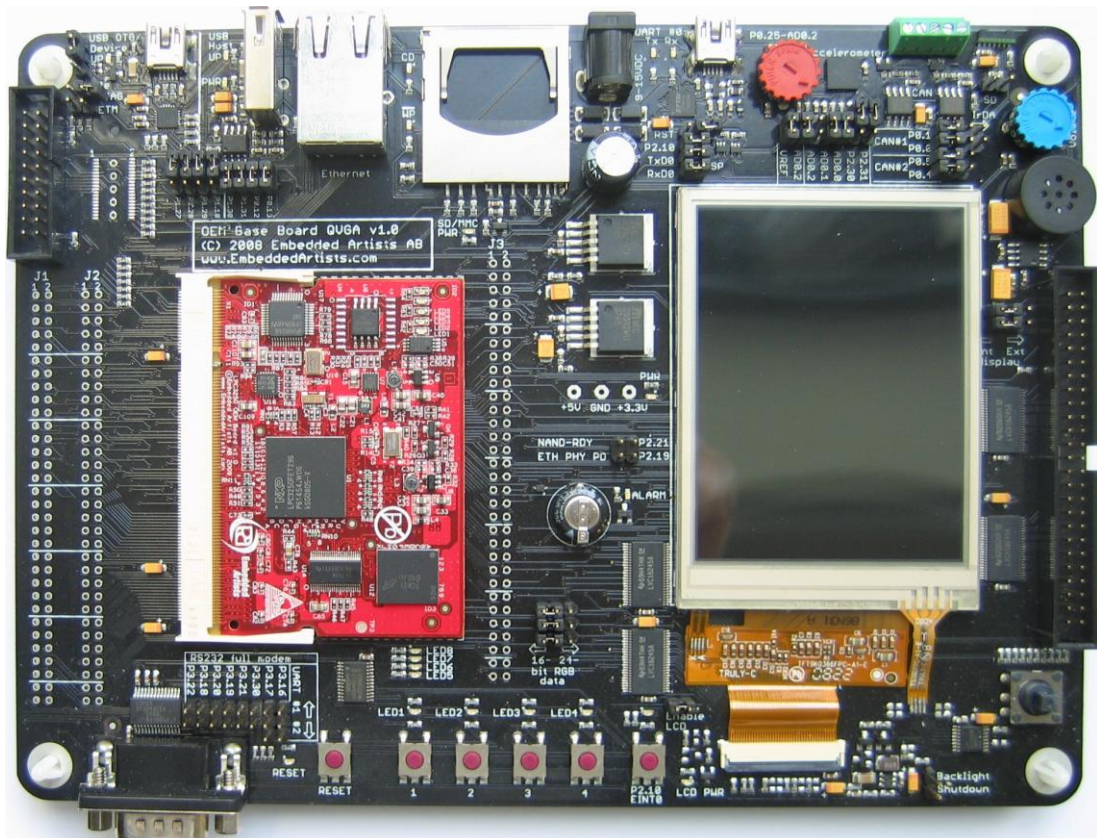

*Get Up-and-Running Quickly and
Start Developing Your Applications On Day 1!*

Embedded Artists AB

Davidshallsgatan 16
SE-211 45 Malmö
Sweden

info@EmbeddedArtists.com
<http://www.EmbeddedArtists.com>

Copyright 2011 © Embedded Artists AB. All rights reserved.

No part of this publication may be reproduced, transmitted, transcribed, stored in a retrieval system, or translated into any language or computer language, in any form or by any means, electronic, mechanical, magnetic, optical, chemical, manual or otherwise, without the prior written permission of Embedded Artists AB.

Disclaimer

Embedded Artists AB makes no representation or warranties with respect to the contents hereof and specifically disclaim any implied warranties or merchantability or fitness for any particular purpose. Information in this publication is subject to change without notice and does not represent a commitment on the part of Embedded Artists AB.

Feedback

We appreciate any feedback you may have for improvements on this document. Please send your comments to support@EmbeddedArtists.com.

Trademarks

All brand and product names mentioned herein are trademarks, services marks, registered trademarks, or registered service marks of their respective owners and should be treated as such.

Table of Contents

1	Document Revision History	5
2	Introduction	6
2.1	Features	6
2.2	ESD and Handling Precaution	7
2.3	LPC3250 Core Voltage Precaution	8
2.4	CE Assessment	8
2.5	Other Products from Embedded Artists	8
2.5.1	Design and Production Services	8
2.5.2	OEM / Education / QuickStart Boards and Kits	8
3	LPC3250 OEM Board Design	9
3.1	LPC3250 OEM Board Schematics	9
3.1.1	Schematic Page 2: Misc	9
3.1.2	Schematic Page 3: Powering	10
3.1.3	Schematic Page 4: External Memories	10
3.1.4	Schematic Page 5: Digital and Analog IO	11
3.1.5	Schematic Page 6: Ethernet Interface	11
3.1.6	Schematic Page 7: USB Interface	11
3.1.7	Schematic Page 8: Expansion Connector	12
3.2	Usage of CPU Pins	12
3.3	LPC3250 OEM Board Mechanical Dimensions and Connector	15
3.4	Things to note about the LPC3250 OEM Board	16
3.4.1	LPC3250 Adjustable Core Voltage	16
3.4.2	NAND FLASH Bad Block	16
3.4.3	Brand of Memory Chips	16
3.4.4	LPC3250 Peripherals	17
4	QVGA Base Board Design	18
4.1	QVGA Base Board Schematics	18
4.2	Signal Mapping to QVGA Base Board	18
4.3	Jumpers	25
4.3.1	Default Jumper Positions	26
4.3.2	Illegal Jumper Combinations	26
4.4	Connectors	27
4.4.1	Mictor-38 ETM Connector	27
4.5	Important Components	28
4.6	USB Interface	29
4.6.1	USB Interface Note	29
5	Getting Started	31
5.1	Initial Setup and Powering	31
5.2	FTDI USB Driver	31
5.2.1	USB Driver Behavior	34

5.3	Building Sample Applications	34
5.3.1	Compile Using CodeSourcery	35
5.3.2	Compile Using Keil's uVision	36
5.4	Booting	36
5.4.1	Kickstart Loader	36
5.4.2	Stage 1 Loader	36
5.4.3	Service Boot	42
6	Further Information	45

1 Document Revision History

<i>Revision</i>	<i>Date</i>	<i>Description</i>
A	2009-10-05	First official revision of document
B	2010-10-18	Added section (4.6) about USB device interface. Updated rework instruction in section (4.6) for USB device interface and R100. Corrected section 5.4.3 about service boot jumpers. Updated to rev 1.3 of OEM board schematic.
C	2011-10-26	Updated section 5.4.2 about how to store an application in NAND flash and execute from external memory.
D	2011-12-19	Added note about CE marking.

2 Introduction

Thank you for buying Embedded Artists' *LPC3250 Developer's Kit* based on NXP's ARM926EJ-S LPC3250 microcontroller.

This document is a User's Guide that describes the *LPC3250 OEM Board* and the *QVGA Base Board* hardware design. It is the User's Manual for both the *LPC3250 Developer's Kit* as well as for just the *LPC3250 OEM Board*.

2.1 Features

Embedded Artists' *LPC3250 Developer's Kit* with NXP's ARM926EJ-S LPC3250 microcontroller lets you get up-and-running quickly. The small sized OEM board offers many unique features that ease your learning curve and speed up your program development. The board has also been designed for OEM applications with volume discount available. The features of the *LPC3250 OEM Board* are:

- NXP's ARM926EJ-S LPC3250 microcontroller in BGA package, with 256 KByte internal RAM
- External data memory: 64 MB DDR SDRAM (16-bit databus width)
- External FLASH memories: 128 MB (1Gbit) NAND FLASH and 4 MB (32Mbit) SPI-NOR FLASH
- 13.0000 MHz crystal for cpu
- 256 Kbit I2C E2PROM for storing non-volatile parameters
- Buffered 16-bit data bus for external expansion
- 200 pos expansion connector (SODIMM-200 format, 0.6mm pitch)
 - Almost all LPC3250 pins available (except dedicated pins for on-board memories and internal powering)
- 3.15-3.3V powering
- Onboard reset generation
- 5 LEDs
- Compact SODIMM size: 66 x 48 mm
 - Eight layer PCB design for compact design and best noise immunity

There is an accompanying *QVGA Base Board* that can be used for initial prototyping work. This base board was originally developed for the LPC2478 processor and the associated *LPC2478 OEM Board* in SODIMM format. Some interfaces, for example the CAN bus and ETM, do not exist on the LPC3250 and can hence not be used. The features of the *QVGA Base Board* are:

- 3.2 inch QVGA TFT color LCD with touch screen (4-wire version)
 - 18-bit RGB interface to display
- Connectors
 - 200 pos, 0.6mm pitch SODIMM connector for the *LPC3250 OEM Board*
 - Expansion connector with all LCD controller signals, for custom displays
 - Expansion connector with all SODIMM interface signals
 - Ethernet connector (RJ45)
 - CAN interface & connector (cannot be used with the *LPC3250 OEM Board*)
 - MMC/SD interface & connector

- JTAG connector
- Pads for *ETM connector* (cannot be used with the *LPC3250 OEM Board*)
- Interfaces
 - USB OTG interface & connector
 - USB host interface & connector
 - Full modem RS232 on UART #1 (cannot be used on 32-bit databus cpu boards, but Rx/D2/Tx/D2 can alternatively be connected to the RS232 interface)
 - Dual CAN interface & connector (cannot be used with the *LPC3250 OEM Board*)
 - IrDA transceiver interface
- Power
 - Power supply, either via USB or external 9-15V DC
- Other
 - 5-key joystick
 - 3-axis accelerometer
 - 5 push-button keys (four via I2C and one on 'gpi01/service_n' (P2.10))
 - 9 LEDs (8 via I2C and one on 'gpi01/service_n' (P2.10))
 - Analog input
 - USB-to-serial bridge on UART #5 (FT232R) and ISP functionality
 - Reset push-button and LED
 - 250x150 mm in size

2.2 ESD and Handling Precaution

Please note that the *LPC3250 OEM Board* and *QVGA Base Board* come without any case/box and all components are exposed for finger touches – and therefore extra attention must be paid to ESD (Electro-Static Discharge) precaution.

Make it a habit always to first touch the metal surface of one of the USB or SC/MMC connectors for a few seconds with both hands before touching any other parts of the boards. That way, you will have the same electrical potential as the board and therefore minimize the risk for ESD damages.

Never touch directly on the *LPC3250 OEM Board* and in general as little as possible on the *QVGA Base Board*. The push-buttons on the *QVGA Base Board* have grounded shields to minimize the effect of ESD.

Note that Embedded Artists does not replace boards that have been damaged by ESD.

Do not exercise excessive pressure on the LCD glass area. That will damage the display. Also, do not apply pressure on the two flex cables connecting the LCD. These are relatively sensitive and can be damaged if too much pressure is applied to them.

Note that Embedded Artists does not replace boards where the LCD has been improperly handled.

2.3 LPC3250 Core Voltage Precaution

The core voltage for the LPC3250 can be dynamically changed, via I2C commands sent to the LTC3447 voltage converter. The voltage can be set to up to 2V. Note that this is above the limits of the core voltage. Read the LPC3250 datasheet for details (the absolute maximum core voltage allowed is 1.39V).

Note that Embedded Artists do not replace LPC3250 OEM boards where the core voltage ($V_{DD(CORE)}$) has been raised above 1.39 Volt. It is the user's responsibility not to exceed the voltage specification found in the datasheet.

2.4 CE Assessment

The *LPC3250 Developers Kit* (consisting of the *LPC3250 OEM Board* and *QVGA Base Board*) is CE marked. See separate *CE Declaration of Conformity* document.

The *LPC3250 Developers Kit* is a class A product. In a domestic environment this product may cause radio interference in which case the user may be required to take adequate measures.

EMC emission test has been performed on the *LPC3250 Developers Kit*. Standard interfaces like Ethernet, USB, serial have been in use. General expansion connectors where internal signals are made available (for example processor pins) have been left unconnected. Connecting other devices to the product via the general expansion connectors may alter EMC emission. It is the user's responsibility to make sure EMC emission limits are not exceeded when connecting other devices to the general expansion connectors of the *LPC3250 Developers Kit*.

Due to the nature of the *LPC3250 Developers Kit* – an evaluation board not for integration into an end-product – fast transient immunity tests and conducted radio-frequency immunity tests have not been executed. Externally connected cables are assumed to be less than 3 meters. The general expansion connectors where internal signals are made available do not have any other ESD protection than from the chip themselves. Observe ESD precaution.

Note that the *LPC3250 OEM board* is classified as a component and is hence not CE marked separately. It can perform different functions in different integrations and it does not have a direct function. It is therefore not in the scope of the CE Directive. An end product, where an *OEM Board* is integration into, is however very likely to need CE marking.

2.5 Other Products from Embedded Artists

Embedded Artists have a broad range of LPC1xxx/LPC2xxx/LPC3xxx/LPC4xxx based boards that are very low cost and developed for prototyping / development as well as for OEM applications. Modifications for OEM applications can be done easily, even for modest production volumes. Contact Embedded Artists for further information about design and production services.

2.5.1 Design and Production Services

Embedded Artists provide design services for custom designs, either completely new or modification to existing boards. Specific peripherals and I/O can be added easily to different designs, for example, communication interfaces, specific analog or digital I/O, and power supplies. Embedded Artists has a broad, and long, experience in designing industrial electronics in general and with NXP's LPC1xxx/LPC2xxx/LPC3xxx microcontroller family in specific. Our competence also includes wireless and wired communication for embedded systems. For example IEEE802.11b/g (WLAN), Bluetooth™, ZigBee™, ISM RF, Ethernet, CAN, RS485, and Fieldbuses.

2.5.2 OEM / Education / QuickStart Boards and Kits

Visit Embedded Artists' home page, www.EmbeddedArtists.com, for information about other *OEM / Education / QuickStart* boards / kits or contact your local distributor.

3 LPC3250 OEM Board Design

Please read the LPC3250 OEM Board datasheet and associated schematic for information about the board. Some additional information about the LPC3250 OEM Board is presented below.

3.1 LPC3250 OEM Board Schematics

3.1.1 Schematic Page 2: Misc

3.1.1.1 Crystals

The microprocessor crystal frequency is 13.0000 MHz, which is the recommended frequency from NXP. An internal PLL can create many other frequencies from this, like 208 MHz and 266 MHz.

The LPC3250 has an internal real-time clock (RTC) block that can be used to provide real-time and alarm function. A 32.768 kHz crystal gives the base frequency for the RTC. The RTC block can be powered via a separate supply (for example from a battery or high-capacity capacitor). The 32.768 kHz can also be used as main oscillator via a PLL: $32.768 \text{ kHz} \times 397 = 13.009 \text{ MHz}$.

Note that the clocking structure is different from the LPC2xxx family. It is a more complex structure but also much more versatile and flexible. There is no shortcut but to read the LPC3250 User's Manual in detail to understand the options and settings.

3.1.1.2 Booting

The LPC3250 starts executing from an on-chip ROM, containing the bootloader. Note that the LPC3250 does not contain any on-chip FLASH memory. Program code must be loaded from an external source into the on-chip SRAM.

The default boot is from an external memory (see LPC3250 User's Manual for details). Program code is typically stored in NAND or SPI-NOR flash.

By pulling pin GPI_01/SERVICE_N low, UART boot mode is activated. This is a method for downloading code from the PC, for example for programming the bootloader for the first time. Note that pin GPI_01/SERVICE_N can be pulled low by pressing the "P2.10" key on the QVGA Base Board.

3.1.1.3 JTAG interface

The JTAG interface is a standard ARM-compatible JTAG interface.

3.1.1.4 SPI NOR FLASH

There is a 32Mbit (4 MByte) NOR flash connected to the SPI bus. Embedded Artists can choose to mount, either S25FL032P from Spansion, AT45DB321 from Atmel, or other, on the board depending on component availability at the time of production. Mounted chips will be supported by the LPC3250 bootloader. However, commands used to program the memory differ. Chip id should always be read out to determine exact type mounted.

3.1.1.5 Reset Generation

The reset generation is handled by a standard voltage supervisor chip, CAT811R from Catalyst Semiconductor. The reset signal will be held active (i.e., low) until the supply voltages, +3.3V, is within margins (above 2.63V). The reset duration is typically 200 mS (consult the CAT811R datasheet for exact details). The output reset signal is push/pull output that is converted to an open-collector / open-drain output via the 74LVC1G125 buffer. An external reset source can pull the reset signal low (with an open-collector/open-drain output). The RESET_N input on the LPC3250 has a 1.2V voltage range (voltage domain: VDD_RTC). A 74LVC1G125 buffer makes sure this voltage range is not exceeded by the external signal RESET_IN (which has 3.3V range).

3.1.1.6 I2C E2PROM

There is a 256 kbit E²PROM accessible via the I²C interface (I2C1). The LPC3250 has two on-chip I²C communication channels (I2C1 and I2C2). More peripheral units are easily connected to the two-wire I²C bus, just as long as the addresses do not collide. The address of the 256kbit E²PROM is 0xA0, which is also indicated in the schematic.

There are 2.2 kohm pull-up resistors (pull-ups are always needed on I²C busses) on the board on both I²C channels.

3.1.2 Schematic Page 3: Powering

3.1.2.1 1.2V and 1.8V Fixed Voltages

The LPC3250 requires three fixed voltages; 1.2V for the core, 1.8V for the memory interface and 3.15-3.3V for the rest of the i/o interfaces. The 1.2V and 1.8V voltages are generated by two LM3671MF step-down switching regulators from National Semiconductor. These regulators are capable of generating 600mA, which by far exceed the needed current by the LPC3250 and other components on the *LPC3250 OEM Board*. The 3.15-3.3V voltage is the input voltage to the *LPC3250 OEM Board*, see below.

The Real-time clock also needs a 1.2V power, which is generated by a LDO (MIC5232).

3.1.2.2 1.2V Adjustable Core Voltage

The core 1.2V voltage is adjustable and is generated by the step down switching regulator LTC3447 from Linear Technologies. This regulator is capable of generating 600mA, which also by far exceed the needed current by the LPC3250. The adjustment is done via an I²C channel, I2C1 in the LPC3250 case. The core voltage can be adjusted as a power save feature. By lowering the voltage (down to 0.9V), the total power consumption can be lowered but the clock frequency of the core must then also be lowered. This is a trade-off that is important for hand held/portable equipment. **Note that it is the user's responsibility not to program the LTC3447 to generate too high core voltage, which is possible.** The LTC3447 can generate voltages up to 2V, which by far exceed the limits for the LPC3250.

See the LPC3250 datasheet for exact details about voltage ranges, but it is in the region of 1.1-1.39V. Also see the LTC3447 datasheet for details about how to adjust the voltage (it is a write-only register). The I²C address for the LTC3447 is indicated in the schematic.

Note that a core voltage of 1.35V should be programmed when working with the external DDR SDRAM.

3.1.2.3 Input Voltage

The input voltage to the *LPC3250 OEM Board* is given by the requirements of the LPC3250. The recommended input voltage range is 3.15V to 3.3V. The input supply must be stable but there are no special needs for bulk capacitors close to the power pins on the expansion connectors. The needed capacitors are placed close to the switched step down switching regulators on the *LPC3250 OEM Board*.

Note that the *LPC3250 OEM Board* is sensitive to input noise on the input voltage. The peak-to-peak noise should be below 10mV. A linear regulator to feed the input voltage is strongly recommended.

3.1.3 Schematic Page 4: External Memories

Page 4 of the schematic contains the external memory interface and the external memories. The memory interface uses a 16-bit databus and operates at 1.8V level, which minimizes power consumption.

3.1.3.1 DDR SDRAM

A 512 MBit (64 MByte) Mobile DDR SDRAM is used (MT46H32M16LF from Micron). The chip is powered by 1.8V and is organized as 32Mbit x16, i.e. it has 16-bit databus width. The chip is connected to EMC_DYCS0_N (memory bank #0 for dynamic RAM) at address range 0x8000 0000 – 0x9FFF FFFF.

Note that memory bank #1 for dynamic RAM is not available (i.e., signal EMC_DYCS1_N is not used).

3.1.3.2 NAND Flash

A 1 Gbit (128 MByte) NAND flash is used (K9F1G08U0A-P from Samsung). The chip is powered by 3.3V and has 8-bit databus width. The NAND flash builds on a single-level cell (SLC) technology and has a page size of 2112 bytes (2,048 + 64 bytes). Note that the chip is not directly accessible via the memory bus. Instead, all accesses must be done via the on-chip NAND flash controller of the LPC3250.

3.1.3.3 Buffers to External Interface

The LPC3250 memory interface is available on the expansion connector. The data bus width is 16-bits on the external interface. The relevant signals are buffered. The following four static memory regions are available for external access:

- External static bank #0 (0xE000 0000 – 0xE0FF FFFF)
16-bit databus width and 16MByte in size.
- External static bank #1 (0xE100 0000 – 0xE1FF FFFF)
16-bit databus width and 16MByte in size.
- External static bank #2 (0xE200 0000 – 0xE2FF FFFF)
16-bit databus width and 16MByte in size.
- External static bank #3 (0xE300 0000 – 0xE3FF FFFF)
16-bit databus width and 16MByte in size.

By default (R44 = 0 ohm, R43 not mounted), signal N_ABUF_EN is pulled low and the two buffers for address and control signals (U13 and U14) are enabled and act as output (from the *LPC3250 OEM Board*).

The buffered version of the LPC3250 signal OE controls the direction of the data bus buffer (U15). During read operations the buffer acts as an input and during write operations it acts as an output. The data bus buffer is controlled by the signals BLS0 and BLS1, each controlling lower and upper bytes of the 16-bit databus. These signals are active when accessing the external static memory regions.

The buffers are dual voltage buffers and act as level translators between the internal 1.8V signal levels and the external levels. Connect the external bus voltage to VDD_EXT. See the datasheet of 74AVCA164245 for exact details about voltage range. Normally 3.3V powering is used on the external side.

3.1.4 Schematic Page 5: Digital and Analog IO

Page 5 of the schematic contains all digital and analog signals plus three LEDs controlled by signals P2.10 - P2.12.

3.1.5 Schematic Page 6: Ethernet Interface

An external PHY (DP83848 from National Semiconductor) implements a 100/10Mbps Ethernet interface. The external PHY is connected to the Ethernet MAC on the LPC3250 via the RMII interface.

3.1.6 Schematic Page 7: USB Interface

There is a USB 2.0 (OTG, Host, Device) interface on the LPC3250. An external PHY (ISP1301) is needed for the cpu.

3.1.7 Schematic Page 8: Expansion Connector

The *LPC3250 OEM Board* integrates the core part of a typical LPC3250 board design with a reasonable large amount of external memories. All relevant signals of LPC3250 are available on the 200 pos, 0.6mm pitch expansion connector (SODIMM-200 format). See the next section for a detailed list of available pins.

3.2 Usage of CPU Pins

Almost all pins of the LPC3250 are directly available on the expansion connectors. Only in a few cases pins are used for dedicated functionality like (dynamic) memory control signals, chip select signals and power supply. Such pins are not available on the expansion connector. The table below lists all pins and their possible restrictions.

Pin	Available on expansion connector
ADIN0 (TS_XM) ADIN1 (TS_YM) ADIN2 (TS_AUX_IN) TS_XOUT TS_YOUT	Yes
I2C1_SCL I2C1_SDA I2C2_SCL I2C2_SDA	Yes, but I2C-E2PROM (U5 – 24LC256) and core voltage generator (U7, LTC3447) connected to I2C1 pins. Note that these signals have 2.2K pull-up resistors.
SPI1_CLK / SCK0 SPI1_DATIO / MOSI0 / MCFB2 SPI1_DATIN / MISO0 / GPI_25 / MCFB1 GPIO_05 / SSEL0 / MCFB0	Yes, but note that SPI NOR flash is connected to these signals.
HIGHCORE / LCDVD[17] ONSW	Yes Note that HIGHCORE signal can control adjustable core voltage of R28 mounted (normally not mounted).
I2S1TX_CLK / MAT3.0 I2S1TX_SDA / MAT3.1 I2S1TX_WS / CAP3.0 MS_BS / MAT2.1 MS_DIO0 / MAT0.0 MS_DIO1 / MAT0.1 MS_DIO2 / MAT0.2 MS_DIO3 / MAT0.3 MS_SCLK / MAT2.0 P0.0 / I2S1RX_CLK P0.1 / I2S1RX_WS P0.2 / I2S0RX_SDA / LCDVD[4] P0.3 / I2S0RX_CLK / LCDVD[5] P0.4 / I2S0RX_WS / LCDVD[6] P0.5 / I2S0TX_SDA / LCDVD[7] P0.6 / I2S0TX_CLK / LCDVD[12] P0.7 / I2S0TX_WS / LCDVD[13] PWM_OUT1 / LCDVD[16] PWM_OUT2 / LCDVD[19] SPI2_CLK / SCK1 / LCDVD[23] SPI2_DATIN / MISO1 / LCDVD[21] / GPI_27	Yes Note: <ul style="list-style-type: none"> • Pull-up on GPI_01/SERVICE_N • GPO_01 and GPO_14 controls LED1/LED2 • GPI_03 has pull-down resistor • GPI_05 has pull-down resistor • GPI_28 has pull-up resistor • U7_HCTS/CAP0.1/LCDCLKIN/ GPI_22 has pull-up resistor • GPO_19 controls NAND write protect signal

SPI2_DATIO / MOSI1 / LCDVD[20] SYSCLKEN / LCDVD[15] TST_CLK2 U1_RX / CAP1.0 / GPI_15 U1_TX U2_HCTS / U3_CTS / GPI_16 U2_RX / U3_DSR / GPI_17 U2_TX / U3_DTR U3_RX / GPI_18 U3_TX U5_RX / GPI_20 U5_TX U6_IRRX / GPI_21 U6_IRTX U7_HCTS / CAP0.1 / LCDCLKIN / GPI_22 U7_RX / CAP0.0 / LCDVD[10] / GPI_23 U7_TX / MAT1.1 / LCDVD[11] GPI_00 / I2S1RX_SDA GPI_01 / SERVICE_N GPI_02 / CAP2.0 / ENET_RXD3 GPI_03 GPI_04 / SPI1_BUSY GPI_05 / U3_DC GPI_06 / HSTIM_CAP / ENET_RXD2 GPI_07 / CAP4.0 / MCABORT GPI_08 / KEY_COL6 / SPI2_BUSY / ENET_RX_DV GPI_09 / KEY_COL7 / ENET_COL GPI_19 / U4_RX GPI_28 / U3_RI GPIO_00 GPIO_01 GPIO_04 / SSEL1 / LCDVD[22] GPO_00 / TST_CLK1 GPO_01 GPO_02 / MAT1.0 / LCDVD[0] GPO_03 / LCDVD[1] GPO_04 GPO_05 GPO_06 / LCDVD[18] GPO_07 / LCDVD[2] GPO_08 / LCDVD[8] GPO_09 / LCDVD[9] GPO_10 / MC2B / LCDPWR GPO_11 GPO_12 / MC2A / LCDLE GPO_13 / MC1B / LCDDCLK GPO_14 GPO_15 / MC1A / LCDFP GPO_16 / MC0B / LCDENAB / LCDM GPO_17 GPO_18 / MC0A / LCDLP GPO_19 GPO_20 GPO_21 / U4_TX / LCDVD[3] GPO_22 / U7_HRTS / LCDVD[14] GPO_23 / U2_HRTS / U3_RTS	
EMC_D19/P2.0 EMC_D20/P2.1 EMC_D21/P2.2	Yes Note that signals can only be P2 signals, not

EMC_D22/P2.3 EMC_D23/P2.4 EMC_D24/P2.5 EMC_D25/P2.6 EMC_D26/P2.7 EMC_D27/P2.8 EMC_D28/P2.9 EMC_D29/P2.10 EMC_D30/P2.11 EMC_D31/P2.12	EMC databus. <ul style="list-style-type: none"> • P2.10 controls LED3 • P2.11 controls LED4 • P2.12 controls LED5
USB_ATX_INT_N USB_DAT_VP / U5_RX USB_I2C_SCL USB_I2C_SDA USB_OE_TP_N USB_SE0_VM / U5_TX	No, connected to on-board USB transceiver, ISP1301
KEY_COL1 / ENET_RX_CLK / ENET_REF_CLK KEY_COL2 / ENET_RX_ER KEY_COL3 / ENET_CRD KEY_COL4 / ENET_RXD0 KEY_COL5 / ENET_RXD1 KEY_ROW3 / ENET_TX_EN KEY_ROW4 / ENET_TXD0 KEY_ROW5 / ENET_TXD1 GPIO_02 / KEY_ROW6 / ENET_MDC GPIO_03 / KEY_ROW7 / ENET_MDIO	No, connected to on-board Ethernet PHY, DP83848
EMC_A00 – EMC_A23	Yes, but only available via the address bus buffer
EMC_D00 – EMC_D15	Yes, but only available via the data bus buffer
EMC_BLS0 EMC_BLS1 EMC_CS0_N EMC_CS1_N EMC_CS2_N EMC_CS3_N EMC_OE_N EMC_WR_N	Yes, but only available via the buffer
FLASH_ALE FLASH_CE_N FLASH_IO00 – FLASH_IO07 FLASH_RD_N FLASH_RDY FLASH_WR_N	No, used for on-board NAND flash memory.
EMC_CAS_N EMC_CKE0 EMC_CLK EMC_DQM0 EMC_DQM1 EMC_DYCS0_N EMC_RAS_N EMC_D16/EMC_DQS0 EMC_D17/EMC_DQS1 EMC_D18/EMC_CLK_N	No, used for on-board DDR SDRAM.

EMC_BLS2 EMC_BLS3 EMC_CKE1 EMC_CLKIN EMC_DQM2 EMC_DQM3 EMC_DYCS1_N	No. These signals are not used and not available.
KEY_COLO / ENET_TX_CLK KEY_ROW0 / ENET_TX_ER KEY_ROW1 / ENET_TXD2 KEY_ROW2 / ENET_TXD3	No. These signals are not used and not available. Note that three (of four) signals can become available if 0 ohm resistors are mounted: <ul style="list-style-type: none"> • KEYROW0, mount R93 • KEYROW1, mount R94 • KEYCOL0, mount R91
JTAG signals	Yes
RESET_N RESOUT_N	Yes Note pull-up resistor on RESET_IN and internal open-drain driving of RESET_IN
RTCX_IN RTCX_OUT SYSX_IN SYSX_OUT	No, directly connected to on-board crystals
All VDD and VSS pins	No, not directly accessible, but ground is available and 3.15-3.3V input voltage
PLL397_LOOP	No, internal on-board connection to signal.

The QVGA Base Board illustrates how to typically connect external interfaces (like USB, external memory devices, etc) to the LPC3250 OEM Board. Study this schematic (also found in this document) for details.

3.3 LPC3250 OEM Board Mechanical Dimensions and Connector

Figure 1 below contains a drawing of the board that includes mechanical measures. See SODIMM-200 standard for exact measures. 1.8V keying is used (SODIMM-200 boards are either 1.8V or 2.5V keyed).

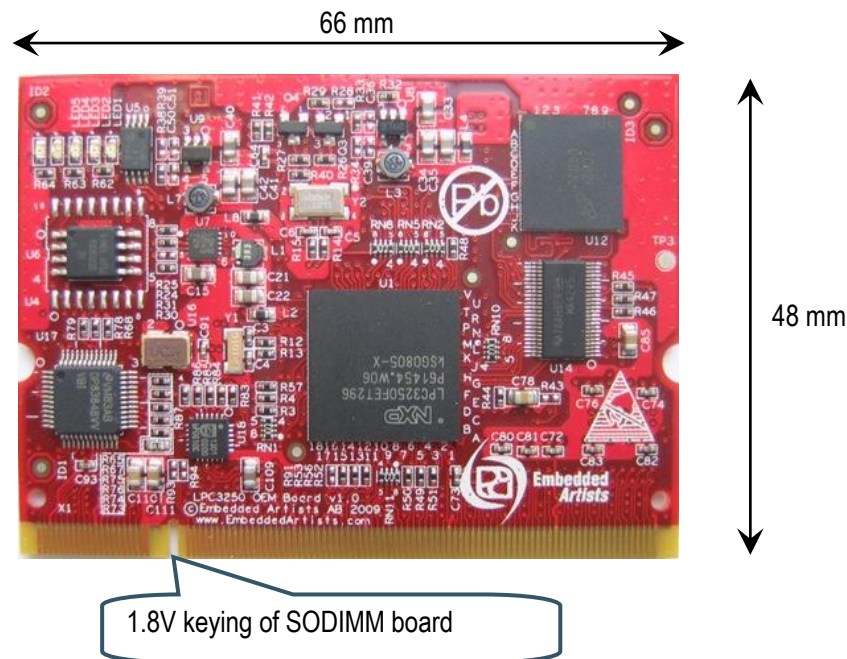

Figure 1 – LPC3250 OEM Board Mechanical Dimensions

The SODIMM-200 format is a standard and there are many connectors that are suitable from many different manufacturers. The many sources also keep the connector cost very low. Note that the connector should be 1.8V keyed.

One suitable connector is 0-1473005-4 from Tyco/AMP. Basically any SODIMM, DDR2, 200pos, 1.8V, right-angled connector will do.

3.4 Things to note about the LPC3250 OEM Board

3.4.1 LPC3250 Adjustable Core Voltage

The core voltage for the LPC3250 is adjustable via I2C commands sent to the LTC3447 voltage converter. The core voltage should always be increased to 1.35 volt in order for external mobile DDR SDRAM to function properly. Initialization code that increase the adjustable core voltage to 1.35V can be downloaded from Embedded Artists support pages.

Note that it is the user's responsibility not to program the LTC3447 to generate too high core voltage, which is possible. The LTC3447 can generate voltages up to 2V, which by far exceed the limits for the LPC3250.

3.4.2 NAND FLASH Bad Block

The NAND Flash is the K9F1G08U0A from Samsung and has 1 GBit capacity. The chip may include invalid blocks when shipped from factory. A maximum of 20 invalid blocks may exist initially, i.e., 1004-1024 valid blocks. Additional invalid blocks may develop while being used. Invalid blocks are defined as blocks that contain one or more bad bits. Do not erase or program factory-marked bad blocks. More information about appropriate management of invalid blocks can be found in technical notes and datasheet from Samsung.

3.4.3 Brand of Memory Chips

Note that there is no guarantee for a certain brand or version of memory chips; SPI-NOR flash, parallel NAND flash and mobile DDR SDRAM. The lifetime of memory chips is limited and availability can also be limited from time to time. Embedded Artists make every effort to mount the original design chip on the board. In case that is impossible a compatible chip will instead be mounted without any prior notice. There can be small programming differences between mounted brands. The application

program shall always read the chip id of flash devices to make certain which chip is actually mounted on the board.

The support page contains datasheets to the different memory devices and information about mounted devices on different board versions.

3.4.4 LPC3250 Peripherals

The *key scan interface* peripheral cannot be used with the *LPC3250 OEM Board* because the Ethernet interface is active.

4 QVGA Base Board Design

Please read the QVGA Base Board schematic for information about the board. Some additional information about the QVGA Base Board is presented below.

4.1 QVGA Base Board Schematics

The *QVGA Base Board* contains a number of interfaces and connectors to the *LPC3250 OEM Board*. The design can be viewed as a reference schematic for custom designs around the *LPC3250 OEM Board*.

4.2 Signal Mapping to QVGA Base Board

The *QVGA Base Board* was originally developed for the *LPC2478* processor and the associated *LPC2478 OEM Board* in SODIMM format. The silk screen on the base board therefore reflects the *LPC2478* signal names.

The table below lists differences between the *LPC3250* and *LPC2478 OEM Boards* in their SODIMM interface. The table also lists what functionality that is connected to the different signals.

SODIMM pin number	LPC2478 OEM Board	LPC3250 OEM Board	QVGA Base Board	Comment
1	ETH_TXP	ETH_TXP	Ethernet i/f	
2	ETH_RXP	ETH_RXP	Ethernet i/f	
3	ETH_TXN	ETH_TXN	Ethernet i/f	
4	ETH_RXN	ETH_RXN	Ethernet i/f	
5	ETH_VDD	ETH_VDD	Ethernet i/f	
6	ETH_GND	ETH_GND	Ethernet i/f	
7	ETH_LED1	ETH_LED1	Ethernet i/f	
8	ETH_LED2	ETH_LED2	Ethernet i/f	
9	VBAT_IN	VBAT_IN	0.33F backup cap on vbat signal	
10	ALARM	ONSW	Connected to alarm-LED (active high)	ONSW functionality not demonstrated/ supported on QVGA Base Board.
11	RESET_IN	RESET_IN	Connects to RESET push-button and USB-to-serial bridge (for automatic ISP functionality)	
12	RESET_OUT	RESET_OUT	Connects to RESET LED indicator. Used to reset PCA9532 and QVGA display.	
13	ETH_PHY_PD	ETH_PHY_PD	Part of Ethernet i/f, can be connected to SODIMM pin 118	
14	JTAG_DBGEN	JTAG_DBGEN	Connected to 'JTAG Enable' jumper	
15	JTAG_TCK	JTAG_TCK	Connected to standard 20 pos (2x10 pin) JTAG connector	
16	JTAG_RTCK	JTAG_RTCK	Connected to standard 20 pos (2x10 pin) JTAG connector	
17	JTAG_NTRST	JTAG_NTRST	Connected to standard 20 pos (2x10 pin) JTAG connector	
18	JTAG_TMS	JTAG_TMS	Connected to standard 20 pos (2x10 pin)	

			JTAG connector	
19	JTAG_TDI	JTAG_TDI	Connected to standard 20 pos (2x10 pin) JTAG connector	
20	JTAG_TDO	JTAG_TDO	Connected to standard 20 pos (2x10 pin) JTAG connector	
21	V3A	VDDA	Positive reference for trimming potentiometer	
22	VREF	NC (can be VCCA)	Can be connected VDDA(V3A)	
23	VSSA	VSSA	Negative reference for trimming potentiometer	
24	GND	GND	GND	
25	P2.0	GPO_10	LCDPWR signal, power enable for QVGA display. Also connects to ETM pads, if connector mounted.	ETM cannot be used
26	P2.1	GPO_12	LCDLE signal. Not used by design. Also connects to ETM pads, if connector mounted.	ETM cannot be used
27	P2.2	GPO_13	LCDDCLK signal, dot clock for QVGA display. Also connects to ETM pads, if connector mounted.	ETM cannot be used
28	P2.3	GPO_15	LCDFP signal, vsync for QVGA display. Also connects to ETM pads, if connector mounted.	ETM cannot be used
29	P2.4	GPO_16	LCDENAB signal, data enable for QVGA display. Also connects to ETM pads, if connector mounted.	ETM cannot be used
30	P2.5	GPO_18	LCDLP signal, hsync for QVGA display. Also connects to ETM pads, if connector mounted.	ETM cannot be used
31	P2.6	P0.2	LCD databit 4. Also connects to ETM pads, if connector mounted.	ETM cannot be used
32	P2.7	P0.3	LCD databit 5. Also connects to ETM pads, if connector mounted.	ETM cannot be used
33	P2.8	P0.4	LCD databit 6. Also connects to ETM pads, if connector mounted.	ETM cannot be used
34	P2.9	P0.5	LCD databit 7. Also connects to ETM pads, if connector mounted.	ETM cannot be used
35	P2.10	GPI_01	Connected to push-button (for enabling bootloader during reset or EINT0 input). Also connects to LED (active low). Connects to USB-to-serial bridge (for automatic ISP functionality)	Enable UART booting by pulling signal low at reset
36	P2.11	U7_HCTS	LCDCCLKIN, an external clock signal can be feed to this pin.	
37	VCC	VCC		
38	GND	GND		
39	VCC	VCC		
40	GND	GND		
41	P0.29-USBA-DP	NC (can be KEYROW0)	Connects to USB device/OTG interface	USB Device/OTG i/f not used
42	P0.31-USBB-DP	USB_CONN_DP	Connects to USB host interface	USB Host interface is connected to the LPC3250
43	P0.30-USBA-DM	NC (can be	Connects to USB device/OTG interface	USB Device/OTG

		KEYROW1)		<i>i/f not used</i>
44	USBB-DM	USB_CONN_DN	Connects to USB host interface	USB Host interface is connected to the LPC3250
45	P2.12	GPO_06	LCD databit 18	
46	P2.13	PWMOUT2	LCD databit 19	
47	P0.0	U6_IRTX	Can be connected to RD1 for CAN channel #1, can also connect to IrDA transceiver	CAN interface cannot be used by the LPC3250. IrDA can be used
48	P0.1	U6_IRRX	Can be connected to TD1 for CAN channel #1, can also connect to IrDA transceiver	CAN interface cannot be used by the LPC3250. IrDA can be used
49	P0.2	U5_TX	Can be connected to USB-to-serial bridge (TxD on UART #5. Note that the silk screen text says UART#0)	Possible to boot over UART#5
50	P0.3	U5_RX	Can be connected to USB-to-serial bridge (RxD on UART #5. Note that the silk screen text says UART#0)	Possible to boot over UART#5
51	P0.4	GPO_02	LCD databit 0, can also be connected to RD2 for CAN channel #2	CAN i/f cannot be used
52	P0.5	GPO_03	LCD databit 1, can also be connected to TD2 for CAN channel #2	CAN i/f cannot be used
53	P0.6	GPO_08	LCD databit 8	
54	P0.7	GPO_09	LCD databit 9	
55	P0.8	PWMOUT1	LCD databit 16	
56	P0.9	HICORE	LCD databit 17	
57	P0.10	U1_TX	Can be connected to RS232 interface (TxD)	
58	P0.11	U1_RX	Can be connected to RS232 interface (RxD)	
59	P0.12	USB_VBUS_CTRL	Can be connected to enable USB-host power switch	
60	P0.13	GPO_17	Can be connected to LED (active low) for USB-host indicator	
61	P0.14	GPO_20	Can be connected to USB-device enable-device signal	
62	P0.15	SPI1_CLK	QVGA display and Touch screen serial interface (SPI-SCK)	
63	P0.16	GPO_04	QVGA display serial interface (SSEL)	
64	P0.17	SPI1_DATIN	QVGA display and Touch screen serial interface (SPI-MISO)	
65	P0.18	SPI1_DATIO	QVGA display and Touch screen serial interface (SPI-MOSI)	
66	P0.19	GPO_05	QVGA display serial interface (command/data select)	
67	P0.20	GPO_11	Touch screen serial interface (SSEL)	
68	P0.21	TS_XP	No special usage on QVGA Base Board	
69	P0.22	TS_YP	No special usage on QVGA Base Board	

70	P0.23	AIN0	Can be connected to accelerometer, X-axis	
71	P0.24	AIN1	Can be connected to accelerometer, Y-axis	
72	P0.25	AIN2	Can be connected to accelerometer, Z-axis, or analog input (trimpot)	
73	P0.26	GPO_00	Connects to speaker output on AOUT signal	
74	P0.27-SDA0	I2C1_SDA	I2C-SDA0, connects to PCA9532 (IO expander)	
75	P0.28-SCL0	I2C1_SCL	I2C-SCL0, connects to PCA9532 (IO expander)	
76	GND	GND		
77	GND	GND		
78	P1.2	MCICLK	Connects to MCICLK on SD/MMC connector	
79	P1.3	MCICMD	Connects to MCICMD on SD/MMC connector	
80	P1.5	GPO_01	Connects to MCIPWR on SD/MMC connector	
81	P1.6	MCIDAT0	Connects to MCIDAT0 on SD/MMC connector	
82	P1.7	MCIDAT1	Connects to MCIDAT1 on SD/MMC connector	
83	P1.11	MCIDAT2	Connects to MCIDAT2 on SD/MMC connector	
84	P1.12	MCIDAT3	Connects to MCIDAT3 on SD/MMC connector	
85	P1.13	GPIO_05	No special usage on QVGA Base Board	
86	P1.18	GPO_14	Connects to QVGA backlight control. Can also be connected to LED (active low) to be used for USB device/OTG	USB Device/OTG if not used
87	P1.19	GPI_13	No special usage on QVGA Base Board	
88	P1.20	U7_RX	LCD databit 10	
89	P1.21	U7_TX	LCD databit 11	
90	P1.22	P0.6	LCD databit 12	
91	P1.23	P0.7	LCD databit 13	
92	P1.24	GPO_22	LCD databit 14	
93	P1.25	SYSCLKEN	LCD databit 15	
94	P1.26	SPI2_DATIO	LCD databit 20	
95	P1.27	SPI2_DATIN	LCD databit 21, can also be connected to ISP1301 (USB OTG transceiver)	ISP1301 on base board shall not be used
96	P1.28	GPIO_04	LCD databit 22, can also be connected to ISP1301 (USB OTG transceiver)	ISP1301 on base board shall not be used
97	P1.29	SPI2_CLK	LCD databit 23, can also be connected to ISP1301 (USB OTG transceiver)	ISP1301 on base board shall not be used
98	P1.30	USB_CONN_VBUS	Can be connected to VBUS signal from USB host power	
99	P1.31	GPI_02	Can be connected to over-current error signal from USB host power switch	
100	NAND_FLASH_RDY	GPO_19	Can be connected to SODIMM pin 119	Signal not used. Exist internally on OEM board.

101	GND	GND		
102	GND	GND		
103	NC	I2S1TX_CLK		
104	NC	I2S1TX_SDA		
105	NC	I2S1TX_WS		
106	NC	P0.0		
107	NC	P0.1		
108	NC	GPI_00		
109	NC	I2C2_SDA		
110	NC	I2C2_SCL		
111	NC	GPI_04		
112	NC	GPI_06		
113	NC	USB_CONN_ID		
114	NC	POWER_ON		
115	NC	TST_CLK2		
116	P2.14	P2.7	Can connect as enable signal for IrDA transceiver (active low)	
117	P2.15	GPIO_00	Can connect to interrupt signal from touch screen controller	
118	P2.19	GPIO_01	Can be connected to Ethernet PHY PD signal, SODIMM pin 13	
119	P2.21	GPI_07	Can be connected to NAND FLASH busy output, SODIMM pin 100	
120	P2.22	P2.0	Connects to joystick switch	
121	P2.23	P2.1	Connects to joystick switch	
122	P2.25	P2.2	Connects to joystick switch	
123	P2.26	P2.3	Connects to joystick switch	
124	P2.27	P2.4	Connects to joystick switch	
125	P2.30	P2.5	Can control sensitivity of accelerometer	
126	P2.31	P2.6	Can control sensitivity of accelerometer	
127	P4.48	GPO_07	LCD databit 2	
128	P4.29	GPO_21	LCD databit 3	
129	GND	GND		
130	GND	GND		
131	BA15	BA15	No special usage on QVGA Base Board	
132	BDQM1	BCS3	No special usage on QVGA Base Board	
133	BA14	BA14	No special usage on QVGA Base Board	
134	BDQM0	BCS2	No special usage on QVGA Base Board	
135	BA13	BA13	No special usage on QVGA Base Board	
136	BCAS	BCS1	No special usage on QVGA Base Board	
137	BA12	BA12	No special usage on QVGA Base Board	
138	BRAS	BCS0	No special usage on QVGA Base Board	

139	BA11	BA11	No special usage on QVGA Base Board	
140	BBLS1	BBLS1	No special usage on QVGA Base Board	
141	BA10	BA10	No special usage on QVGA Base Board	
142	BBLS0	BBLS0	No special usage on QVGA Base Board	
143	BA9	BA9	No special usage on QVGA Base Board	
144	BWE	BWE	No special usage on QVGA Base Board	
145	BA8	BA8	No special usage on QVGA Base Board	
146	BOE	BOE	No special usage on QVGA Base Board	
147	BA7	BA7	No special usage on QVGA Base Board	
148	BA23	BA23	No special usage on QVGA Base Board	
149	BA6	BA6	No special usage on QVGA Base Board	
150	BA22	BA22	No special usage on QVGA Base Board	
151	BA5	BA5	No special usage on QVGA Base Board	
152	BA21	BA21	No special usage on QVGA Base Board	
153	BA4	BA4	No special usage on QVGA Base Board	
154	BA20	BA20	No special usage on QVGA Base Board	
155	BA3	BA3	No special usage on QVGA Base Board	
156	BA19	BA19	No special usage on QVGA Base Board	
157	BA2	BA2	No special usage on QVGA Base Board	
158	BA18	BA18	No special usage on QVGA Base Board	
159	BA1	BA1	No special usage on QVGA Base Board	
160	BA17	BA17	No special usage on QVGA Base Board	
161	BA0	BA0	No special usage on QVGA Base Board	
162	BA16	BA16	No special usage on QVGA Base Board	
163	DBUS_EN	NC (can connect to KEYCOL0)		
164	ABUF_EN	ABUF_EN		
165	VCC	VDD_EXT		
166	GND	GND		
167	BD15	BD15	Occupied by 16-bit databus. No special usage on QVGA Base Board	
168	BD31/P3.31	GPI_08	No special usage on QVGA Base Board	
169	BD14	BD14	Occupied by 16-bit databus. No special usage on QVGA Base Board	
170	BD30/P3.30	GPO_23	No special usage on QVGA Base Board.	
171	BD13	BD13	Occupied by 16-bit databus. No special usage on QVGA Base Board	
172	BD29/P3.29	GPI_09	No special usage on QVGA Base Board	
173	BD12	BD12	Occupied by 16-bit databus. No special usage on QVGA Base Board	
174	BD28/P3.28	GPI_19	No special usage on QVGA Base Board	
175	BD11	BD11	Occupied by 16-bit databus. No special usage on QVGA Base Board	

176	BD27/P3.27	P2.8	No special usage on QVGA Base Board	
177	BD10	BD10	Occupied by 16-bit databus. No special usage on QVGA Base Board	
178	BD26/P3.26	P2.9	No special usage on QVGA Base Board	
179	BD9	BD9	Occupied by 16-bit databus. No special usage on QVGA Base Board	
180	BD25/P3.25	P2.10	No special usage on QVGA Base Board	
181	BD8	BD8	Occupied by 16-bit databus. No special usage on QVGA Base Board	
182	BD24/P3.24	P2.11	No special usage on QVGA Base Board	
183	BD7	BD7	Occupied by 16-bit databus. No special usage on QVGA Base Board	
184	BD23/P3.23	P2.12	No special usage on QVGA Base Board	
185	BD6	BD6	Occupied by 16-bit databus. No special usage on QVGA Base Board	
186	BD22/P3.22	GPI_28	No special usage on QVGA Base Board.	
187	BD5	BD5	Occupied by 16-bit databus. No special usage on QVGA Base Board	
188	BD21/P3.21	U2_TX	No special usage on QVGA Base Board.	
189	BD4	BD4	Occupied by 16-bit databus. No special usage on QVGA Base Board	
190	BD20/P3.20	U2_RX	No special usage on QVGA Base Board.	
191	BD3	BD3	Occupied by 16-bit databus. No special usage on QVGA Base Board	
192	BD19/P3.19	GPI_05	No special usage on QVGA Base Board.	
193	BD2	BD2	Occupied by 16-bit databus. No special usage on QVGA Base Board	
194	BD18/P3.18	U2_CTS	No special usage on QVGA Base Board.	
195	BD1	BD1	Occupied by 16-bit databus. No special usage on QVGA Base Board	
196	BD17/P3.17	U3_RX	Can be connected to RS232 interface	
197	BD0	BD0	Occupied by 16-bit databus. No special usage on QVGA Base Board	
198	BD16/P3.16	U3_TX	Can be connected to RS232 interface	
199	VCC	VDD_EXT		
200	GND	GND		

4.3 Jumpers

The QVGA Base Board has a number of jumpers in order to be able to connect/disconnect and fully utilize all functionality of the LPC3250 and the boards. Figure 2 illustrates all jumpers and explains to what part of the design they belong.

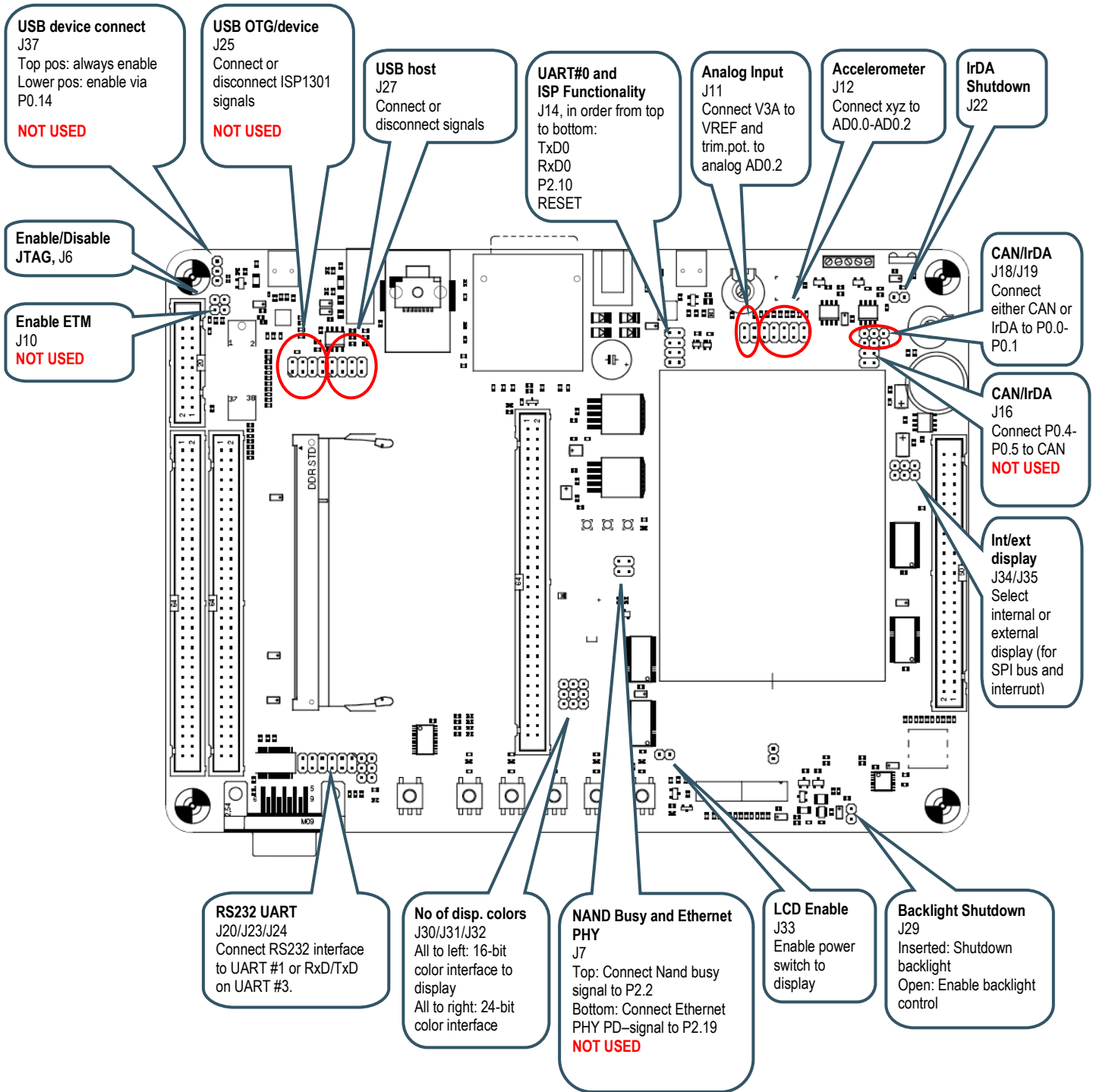

Figure 2 – QVGA Base Board Jumpers

4.3.1 Default Jumper Positions

The figure below illustrates the default jumper positions as mounted when the board is delivered from Embedded Artists.

Note that the "Enable JTAG" jumper shall **NOT** be inserted. The enable state is different for the LPC3250 than on the LPC2478 (which the QVGA Base Board was originally designed for).

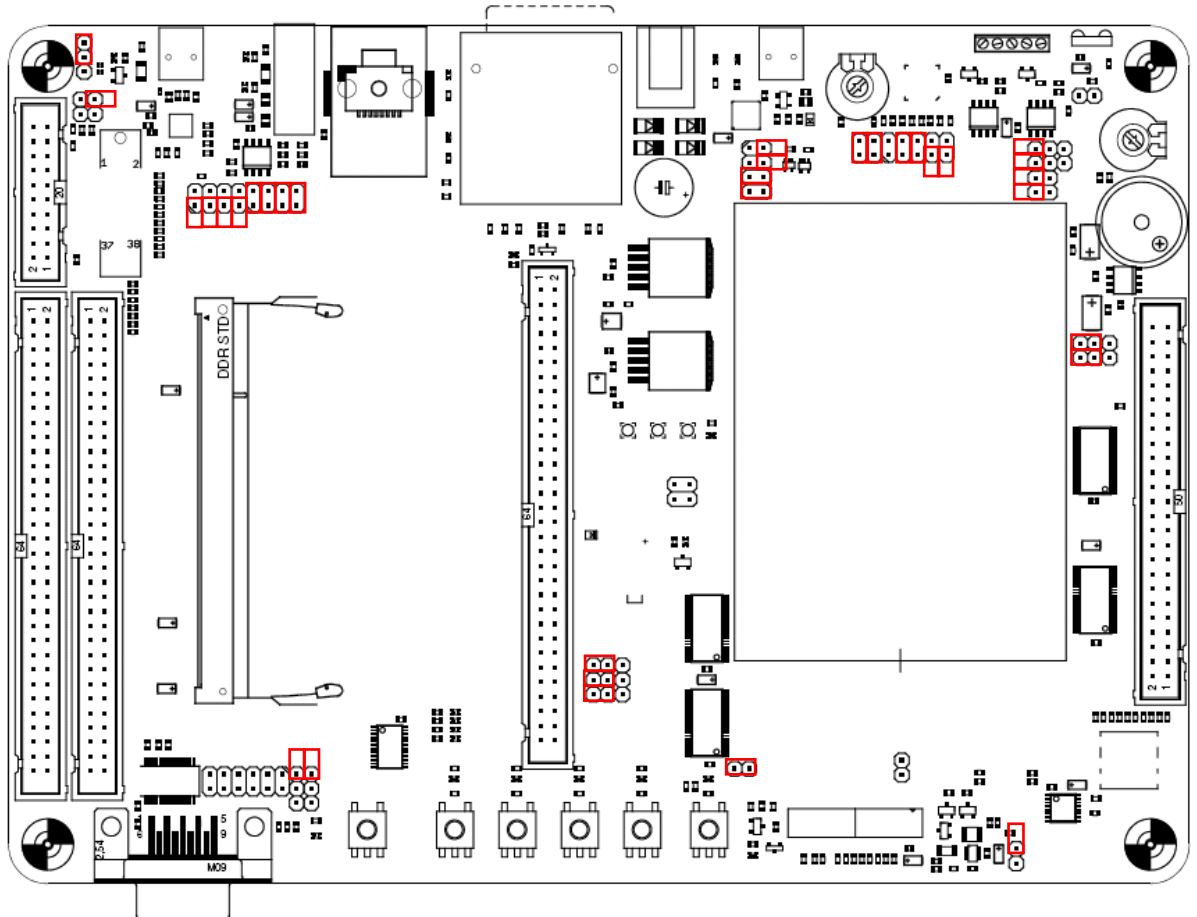

Figure 3 – QVGA Base Board Default Jumper Positions

4.3.2 Illegal Jumper Combinations

Note that some jumpers are mutual exclusive and should not be inserted simultaneously.

- USB-OTG and LCD interface; the four jumpers in J25 should not be inserted when using the LCD interface since signals (P1.27-P1.29) are also connected to the ISP1301.

4.4 Connectors

The figure below illustrates the position of all external connectors on the QVGA Base Board.

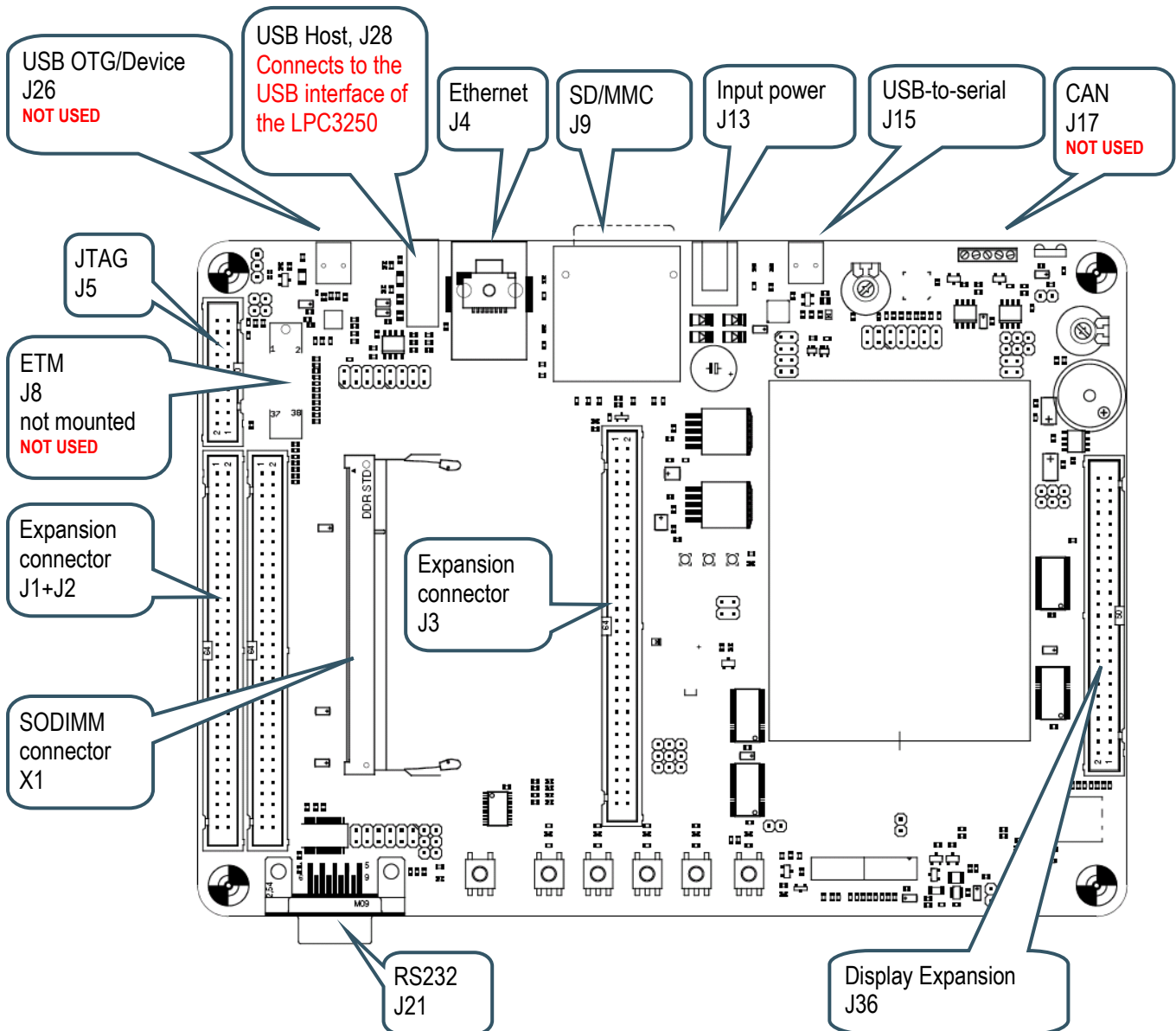

Figure 4 – QVGA Base Board External Connectors

4.4.1 Mictor-38 ETM Connector

The ETM connector is not mounted on the board. It's designated J6. The connector can be soldered to the board if needed **but it cannot be used with the LPC3250**. It is only for the LPC24xx processor family.

4.5 Important Components

The figure below illustrates the position on the *QVGA Base Board* for some important components in the design.

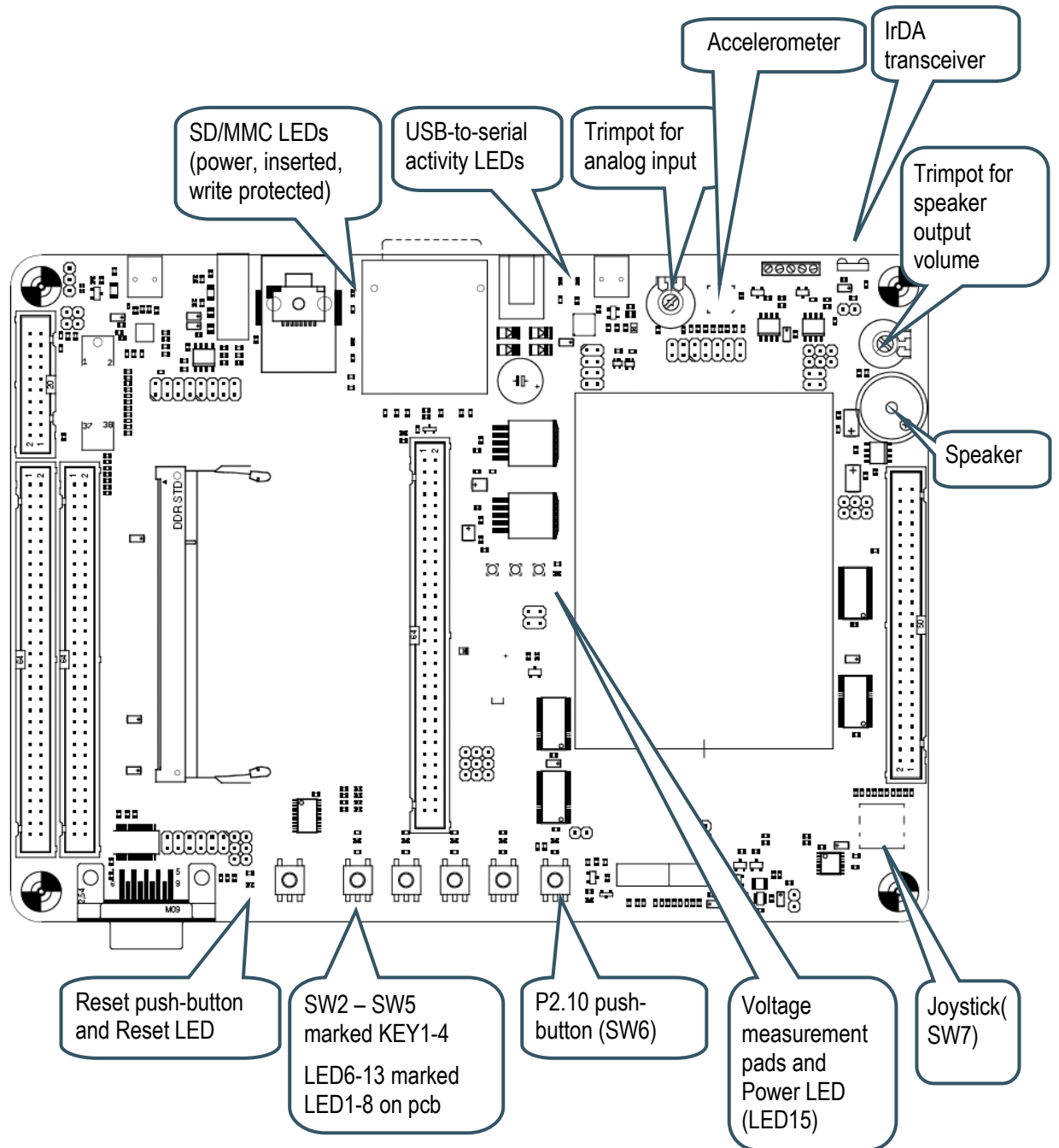

Figure 5 – QVGA Base Board Important Components

4.6 USB Interface

The OTG USB interface of the LPC3250 is connected to the USB Host interface on the *QVGA Base Board*. Note that the LPC3250 USB interface can only be accessed via the USB Host interface connector, J28, on the *QVGA Base Board*. Connector J26 (USB OTG/Device) on the *QVGA Base Board* is **not** connected at all.

When the LPC3250 USB interface is used as a USB Host interface the *QVGA Base Board* connector (J28) is the correct one.

When the LPC3250 USB interface is used as a USB Device interface then an adapter is needed for J28. Two alternatives exist:

- Use a USB-A (male) to USB-mini-B (female) adapter
- Use a USB-A (male) to USB-A (male) cable when connecting to for example a PC.

4.6.1 USB Interface Note

When working in USB Device mode, there have been a few reports about incorrect operation on some (not all) boards. The problem has been traced back to R100, which is 10K on *QVGA Base Board* rev 1.0 and rev 1.1. By lowering R100 to 1Kohm, USB Device operation works on these boards. This has been done on *QVGA Base Board* rev 1.2 so no further actions are needed on this revision of the base board.

See the picture below for an illustration how to change R100. Either replace it (but it is not so easy to solder R100 (0603 sized) since it is between the USB Host and Ethernet connectors) or just add a 1K resistor on the backside (as illustrated in *Figure 7*).

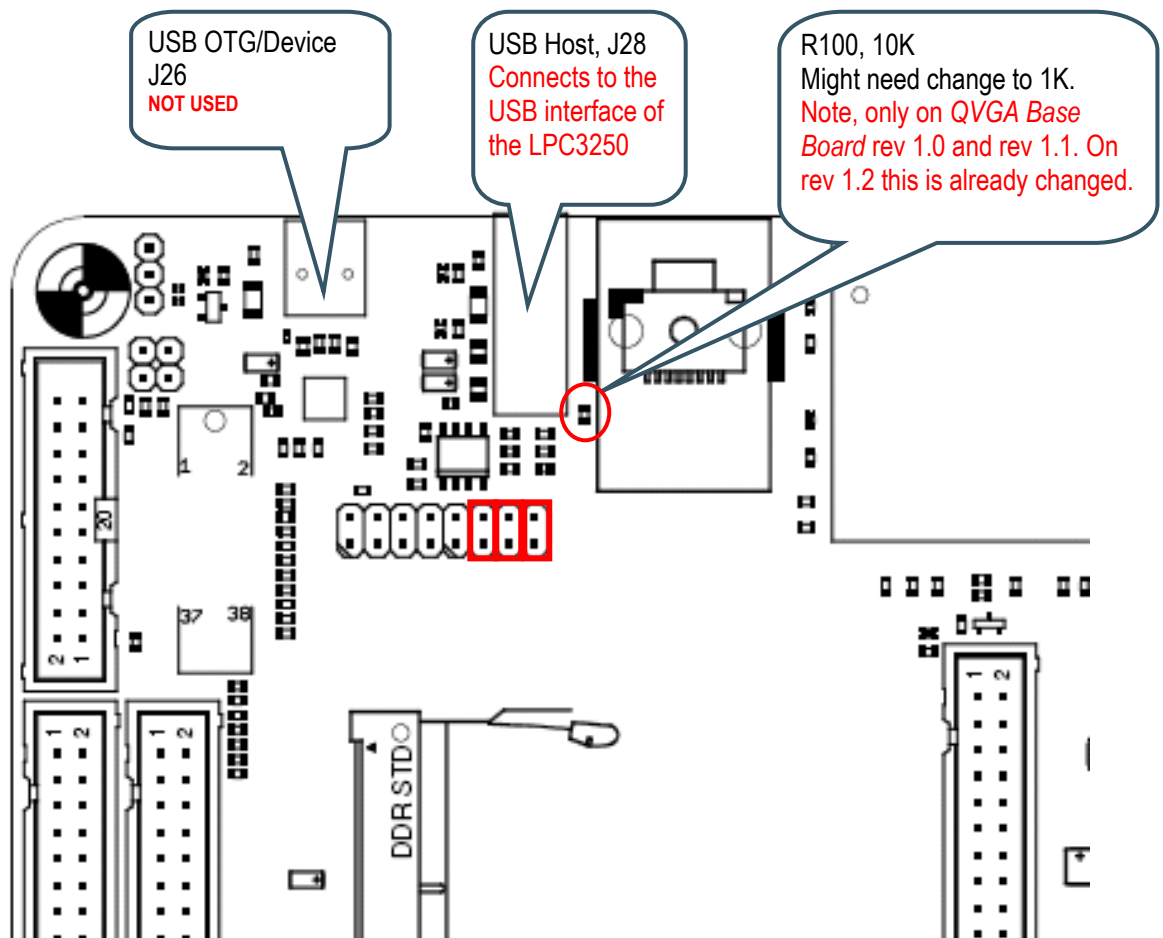
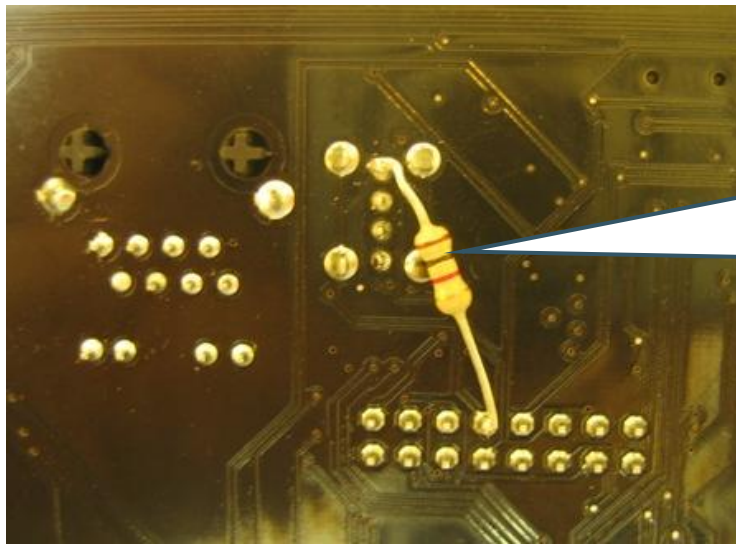

Figure 6 – QVGA Base Board USB Connectors



Change R100 value by connecting a 1K resistor between the VBUS pin of the USB Host connector (J28) and the pin list, as illustrated.

Figure 7 – QVGA Base Board USB Device Fix of R100

5 Getting Started

This chapter contains information about how to get acquainted with the *LPC3250 Developer's Kit*. **Please read this section first before you start using the board - it will be worthwhile!**

5.1 Initial Setup and Powering

The board can be powered from a PC via the included USB cable (mini-B to A cable). A separate power supply is however needed in stand-alone situations or when running USB Host application (when powering heavy load external USB devices). The power supply should be 9-15V DC, 2 Amp. A 2.1mm standard power plug is used to interface the board. Any polarity is accepted.

It is possible to have both the USB cable and external powering connected to the board at the same time.

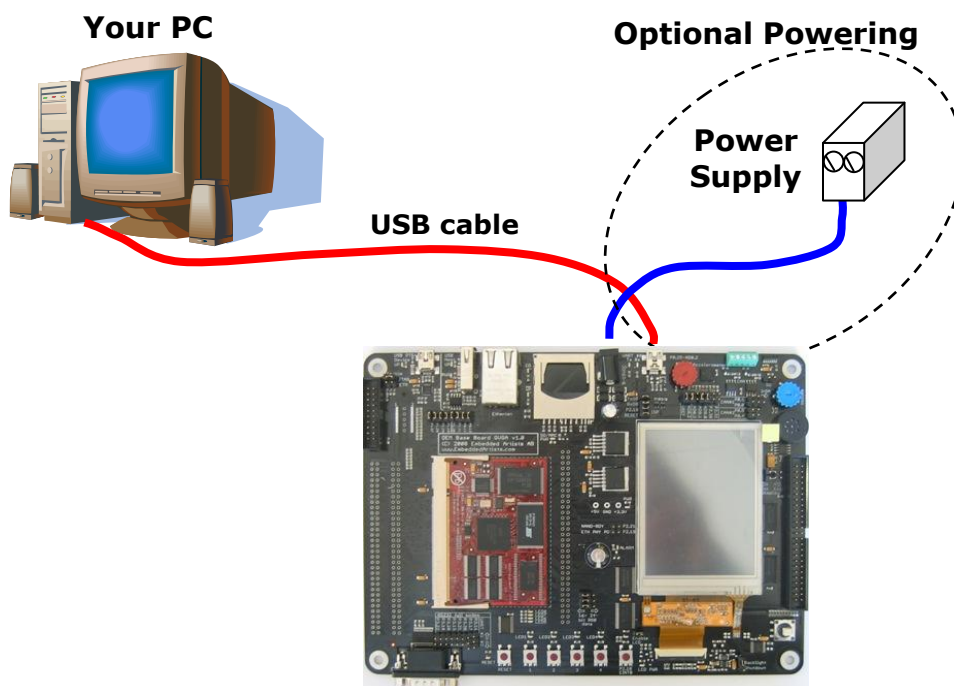

Figure 8 – Powering of QVGA Base Board

The *QVGA Base Board* contains a USB-to-Serial bridge chip (FT232R from FTDI) that connects the UART channel #5 on the LPC3250 to a virtual COM port on the PC (via USB). It is this serial channel that is the console interface to the system.

Special USB drivers must be installed on the PC in order for the virtual COM port to be created. See *Section 5.2* for a description of how to install the FTDI USB driver.

5.2 FTDI USB Driver

A USB driver must be installed on your PC computer in order to get the USB-to-UART chip (FT232R) to work. Make sure to download the latest version of the driver, which can be found at the following URL: <http://www.ftdichip.com/Drivers/VCP.htm> (search for a FT232R driver for your operating system).

When the *QVGA Base Board* is connected to the PC (via a USB cable) the PC will ask for a driver. Unpack/unzip the downloaded driver file and browse to the position of the driver files. After successful driver installation, a COM port will be created. Before any communication with the Board can take place the UART settings must be set correctly. The following description is valid for Windows™ XP, but other operating systems have similar dialog windows. See the USB driver documentation for details, if needed.

To change the UART settings, first open the System Properties dialog, as illustrated in the figure below.

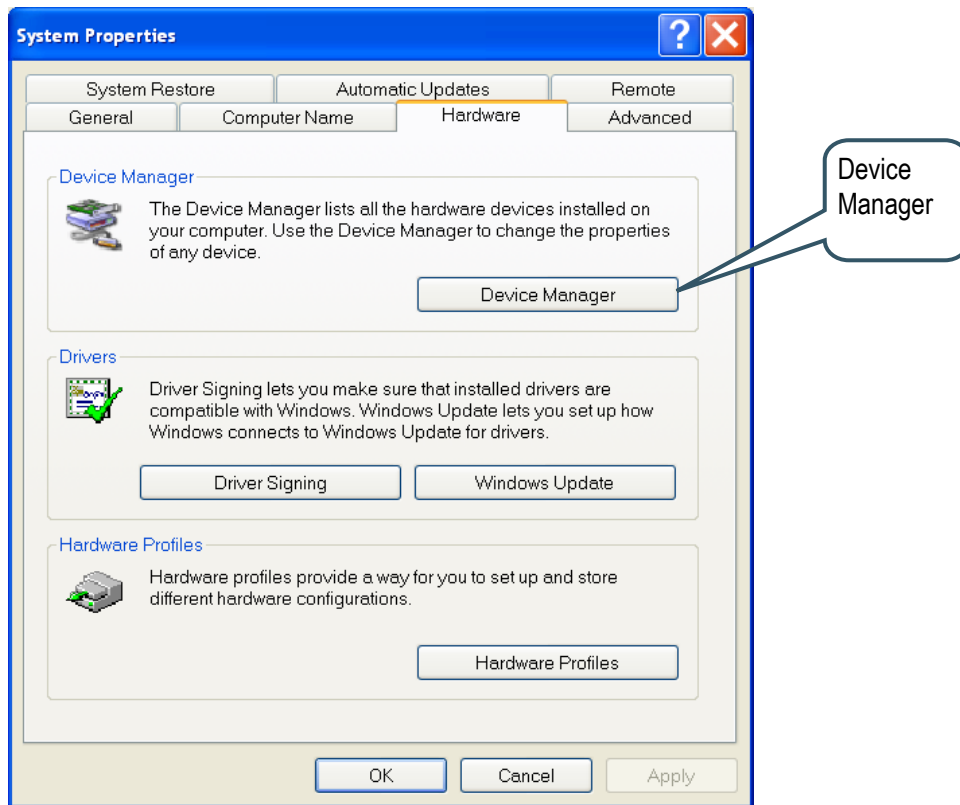

Figure 9 – System Settings Dialog

Then select the *Device Manager* and open the *Ports* list, as illustrated in Figure 10.

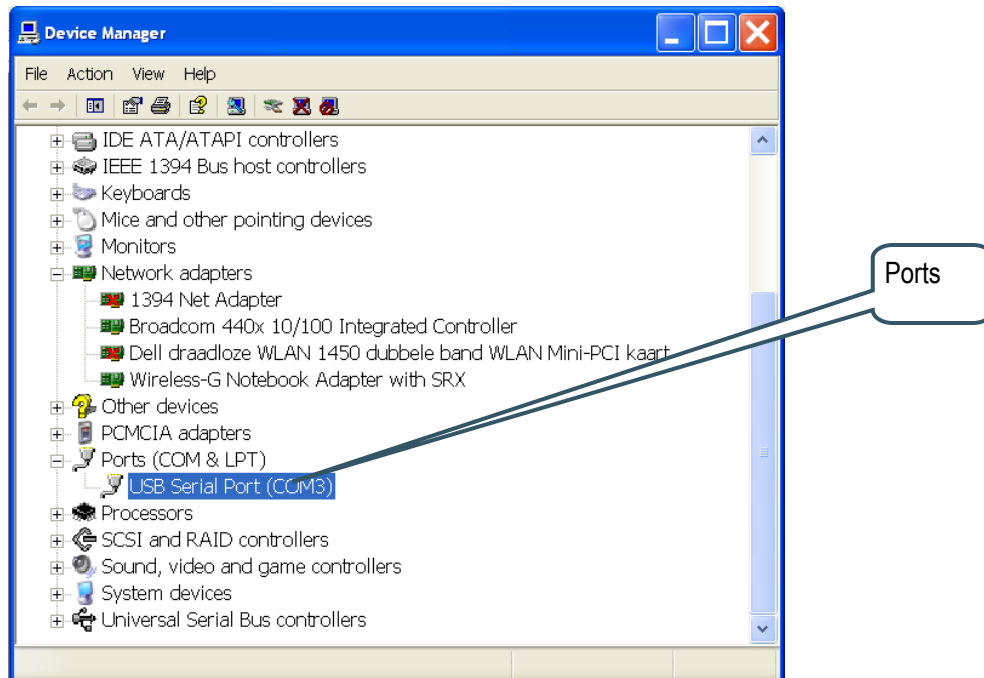

Figure 10 – Device Manager Dialog

The new COM port (USB Serial Port) will be listed under the *Ports* list. Right-click on the new USB Serial Port and select *Properties*, as illustrated in *Figure 11* below.

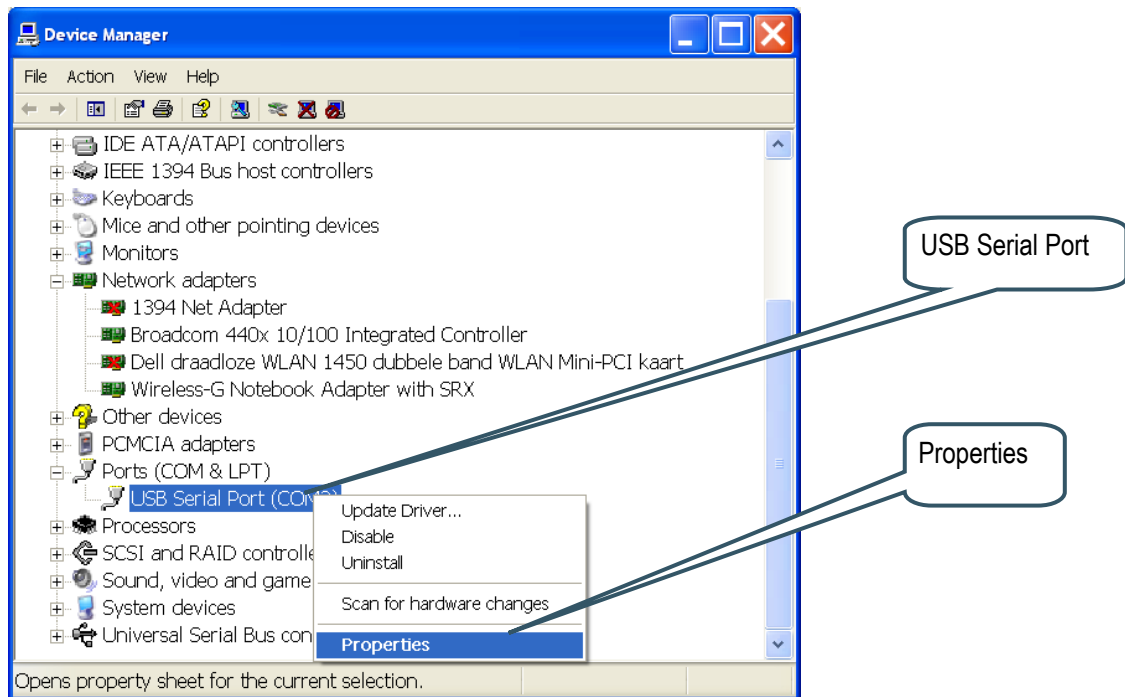

Figure 11 – Device Manager Port Dialog

Select 115200 bits per second, 8 data bits, none parity, 1 stop bit, and none flow control, as illustrated in *Figure 12* below. Then select *Advanced* settings. Please note that different application programs can use different baud rate settings for the serial channel. Other baud rates can also be used, depending on your specific application.

Also note that it is normally not needed to set the used baud rate at all. The driver and FT232R chip will automatically handle different baud rates. The setting is only shown here for completeness.

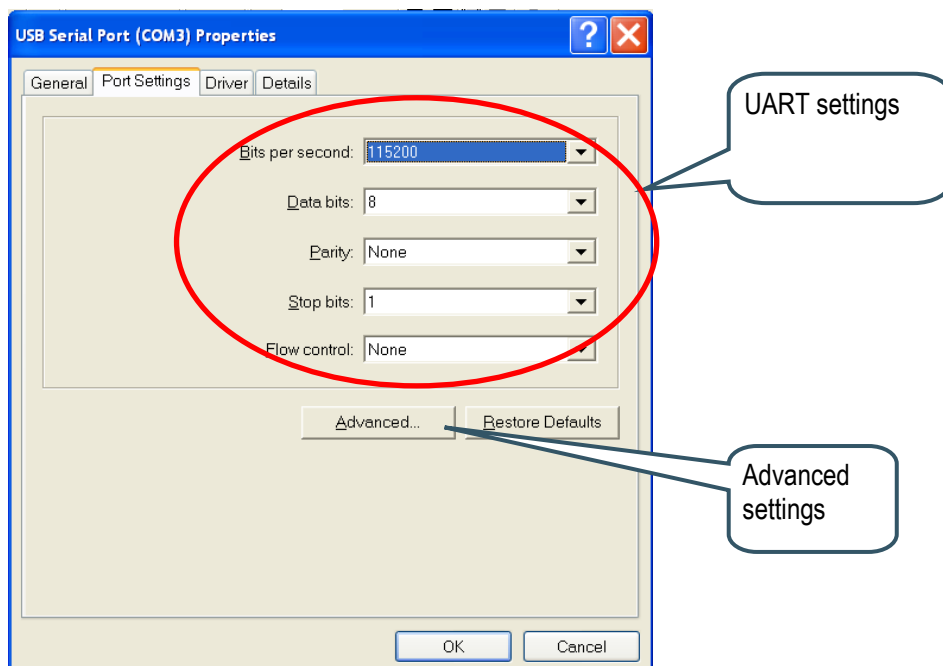

Figure 12 – USB Serial Port Properties Dialog

Select the desired COM port number under the *Advanced* settings dialog. NXP's FLASH Utility program (for ISP program download) needs, for example, a COM port number between 1 and 5. Often the COM port number is selected but the USB Serial Port is higher than that and needs to be changed manually.

It is common that all COM ports with low numbers are listed as occupied, but try to change to a low number anyway. Very often it is no problem at all to do so.

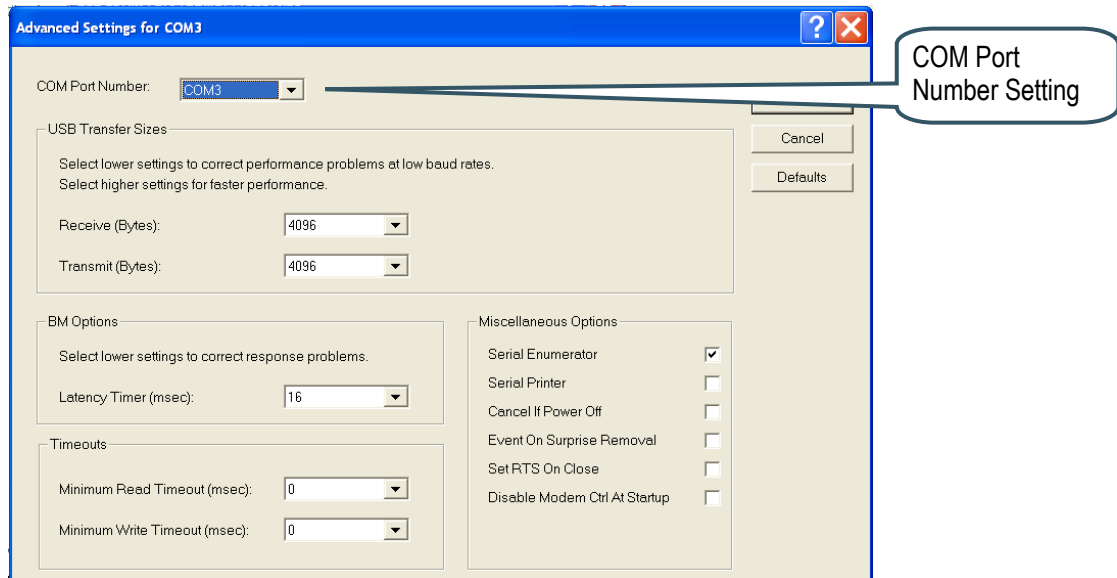

Figure 13 – Advanced USB Serial Port Properties Dialog

Finally it is time to test if you have successfully installed and configured the USB Serial Port. Start a terminal program. Connect to the correct COM port, with 115200 bits per second, 8N1, no flow control.

5.2.1 USB Driver Behavior

Sometimes the USB COM port does not enumerate properly when the board is connected to the PC. This is a known “feature” of the USB driver. If you experience this problem, just unplug the board shortly and then plug it in again. A new COM port that can be accessed properly should be created the second time.

This problem may occur after every time you start (i.e., power cycle) your PC.

5.3 Building Sample Applications

A bundle with sample applications is available at Embedded Artists' support site. These applications illustrate the use of different peripherals on both the *LPC3250 OEM Board* and the *QVGA Base Board*. The sample applications have been developed using the Common Driver Library (CDL) framework developed by NXP.

The CDL framework contains start-up code, initialization of clocks and drivers for the peripherals on the microcontroller. The file structure, see figure below, is organized in a way where chip specific code is separated from board specific code and the structure also supports using different build environment such as CodeSourcery's GNU tools or Keil's uVision.

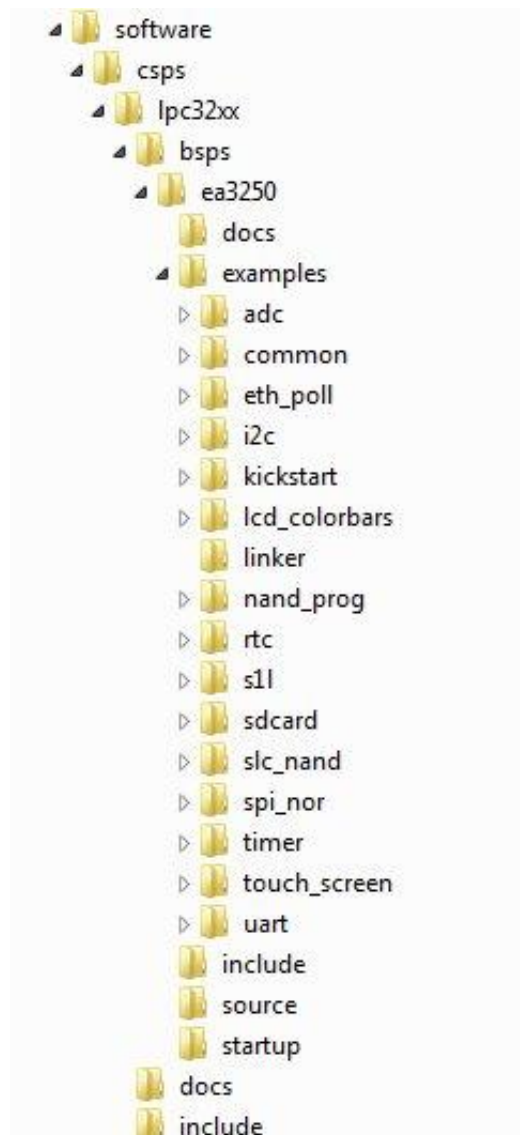

Figure 14 – Common Driver Library Structure

5.3.1 Compile Using CodeSourcery

This section describes how you compile an application using the CodeSourcery GNU tools. Please **note** that there is no guarantee that all applications provided by Embedded Artists will be able to compile using CodeSourcery GNU since the main tool is Keil's uVision.

1. Download the CodeSourcery Tools from www.codesourcery.com. The tool is called Sourcery G++ and there is a *Lite Edition* available for free after a registration. Select the version for ARM processors and with the EABI target OS.
2. Download the sample applications from Embedded Artists support site and unzip the file.
3. Start a command prompt (Start button → run → cmd)
4. Change to the software directory in the recently unzipped file.
5. Run `setenv ea3250 gnu`.
6. Change directory to the sample application you would like to compile, for example, `software/csps/lpc32xx/bsps/ea3250/examples/timer`
7. Run `make` to compile the sample application.

8. A .bin file as well as a .srec file will be generated that can be used for booting.

5.3.2 Compile Using Keil's uVision

This section describes how you can compile an application using Keil's uVision.

1. You must have Keil's uVision installed on your computer. An evaluation version can be downloaded from www.keil.com.
2. Download the sample applications from Embedded Artists support site and unzip the file.
3. The sample applications contain Keil project files. Double click on the file with extension Uv2 and the Keil uVision tool will be started.
4. Press the F7 key or go to the *Project* menu and select *Build Target*.
5. If you have a USB-JTAG adapter connected between the *LPC3250 OEM Board* and your computer you can directly download the application to internal RAM of the LPC3250. You do this by pressing CTRL+F5 keys or by going to the Debug menu and selecting the Start/Stop Debug Session alternative.
6. If you don't have a USB-JTAG adapter you can program the board with the generated bin file.

5.4 Booting

The processor will start its code execution from an internal ROM, containing the boot code. This boot loader can load code from one of four external sources to internal RAM (IRAM) at address 0x0.

- UART5
- SSP0 (in SPI mode)
- EMC Static CS0 memory
- NAND FLASH

The boot loader loads code as a single contiguous block at a maximum size of **56 kByte**. Programs larger than this size must be loaded in more steps, for example, by a secondary boot loader.

The LPC3250 User's Manual from NXP (chapter 35) contains all details about booting. The rest of this section gives an overview of what is supported by the *LPC3250 OEM Board* and *QVGA Base Board*, and how to quickly get started with the download process.

5.4.1 Kickstart Loader

By default the Embedded Artists *LPC3250 OEM Board* is programmed with the kickstart loader in block 0 of the NAND flash. The responsibility of this loader is to load an application stored in block 1 and onwards of the NAND flash. The kickstart loader will load the application into internal RAM (IRAM) at address 0x0.

The kickstart loader is available in the bundle with sample applications provided by Embedded Artists (examples/kickstart). The application `nand_prog` (examples/nand_prog) is used to program the NAND flash with the kickstart loader as well as a second application, for example, the stage 1 loader.

5.4.2 Stage 1 Loader

By default the Embedded Artists *LPC3250 OEM Board* is programmed with the stage 1 loader (s1l) in block 1 of the NAND flash. This application will be loaded by the kickstart loader when the *LPC3250 OEM Board* powers up, see figure below.

```

COM5:115200baud - Tera Term VT
File Edit Setup Control Window Resize Help
5Kickstart bootloader started
Detected NAND Flash ID is: flec
Kickstart: reading application data
Kickstart: starting application

Embedded Artists LPC3250 board
Build date: May 20 2009 13:10:03
Autoboot in progress, press any key to stop

ea3250>

```

Figure 15 – S1L loader up and running

The S1L loader will initialize the board, such as clocks and external memory and then start a console where you can give input commands to the loader. S1L offers the following booting options.

- MMC/SD card
- UART5
- NAND Flash

Load application from MMC/SD card

First make sure you have stored the srec file on the FAT formatted MMC/SD card. Please note that the S1L loader doesn't support long file names.

1. Load srec file to memory

```
ea3250> load blk timer~1.sre srec
```

2. Start the application using the `exec` command

```
ea3250> exec
```

If the application has been built and linked to execute from external memory you could also use the binary file when loading the application. This is, for example, the case for the u-boot bootloader.

1. Load the binary file with type set to `raw`.

```
ea3250> load blk u-boot.bin raw 0x83fc0000
```

2. Start the application using the `exec` command and the load address.

```
ea3250> exec 0x83fc0000
```

Instead of directly executing the binary file you could store it in NAND flash by issuing the `nsave` command after it has been loaded to the external memory.

Load application from UART

Loading from UART is similar to loading from MMC/SD card with the difference that source is set to `term`.

1. Start the download process.

```
ea3250> load term srec
```

2. Start to transfer the srec file using your terminal application
3. When the application has been transferred, the prompt will return and you can execute the application

```
ea3250> exec
```

More commands are available in the S1L loader and you can use the `help` command to find out more about how to use them.

Store Application in NAND Flash and Execute From External Memory

Note: These instructions are only valid for the sample applications based on the CDL2 package.

By default the sample applications found in the zip file on Embedded Artists support site have been setup to run from internal memory which is especially suitable when testing and developing an application. The application is downloaded directly to the internal memory through, for example, a JTAG adapter.

When an application should be stored persistently on the LPC3250 OEM Board the NAND flash is a suitable place to store it since the LPC3250 microcontroller doesn't have any on-chip flash. It can also be suitable to run the application from external memory especially if it is too large to fit into internal memory. These instructions show how to build the applications (using Keil uVision) so that they can be run from external memory and also how to store that application in NAND flash.

1. Open the project in Keil uVision
2. Make sure board initialization isn't executed when the application is built for external memory. The S1L boot loader will take care of initialization and it shouldn't be executed twice. Go to Project → Options → Asm. **Remove** the `USE_BOARD_INIT` define.

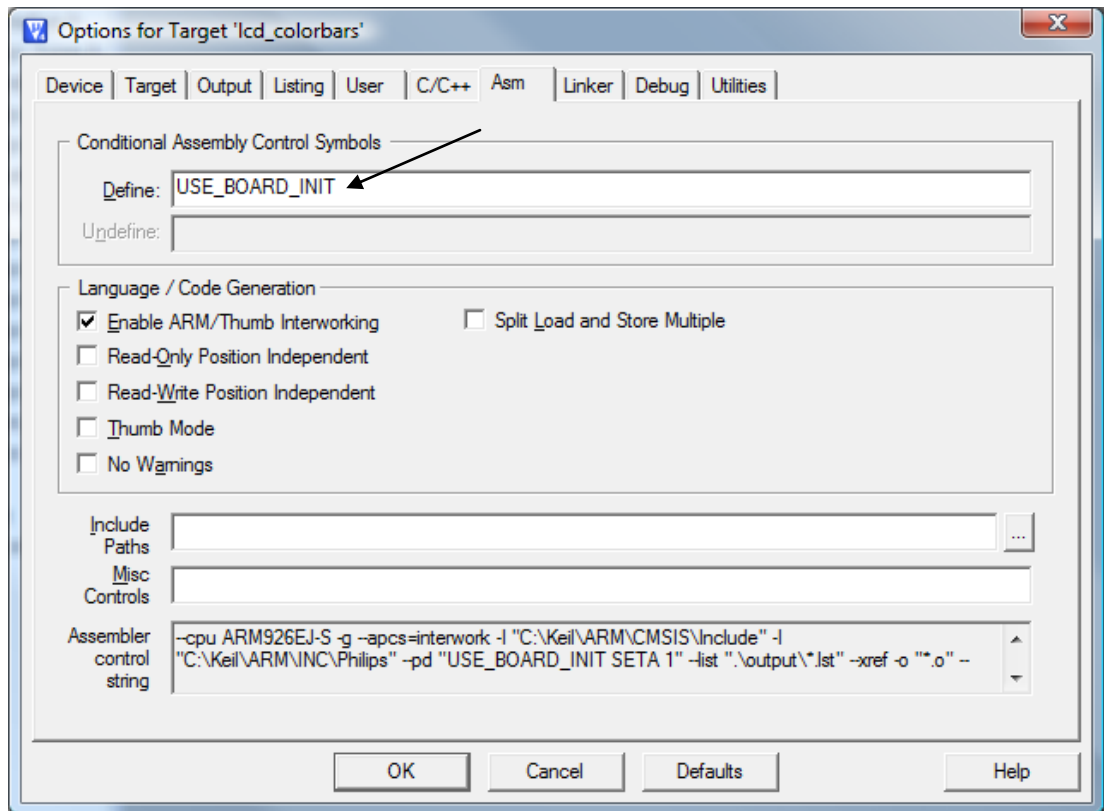

Figure 16 – Asm settings in Keil uVision

3. Change linker script so that the application runs from external memory instead of internal memory. Go to Project → Options → Linker. Click Edit button to the right on the Scatter File. The scatter file will now be opened. **Please note** that this file is common for all sample applications. If only one application should be changed copy this file to the local project instead of changing the common file.

Change the LR_RAM1 row. The first argument is the execute address which could be changed to `0x80000000` if the application should be run from the beginning of the external memory. The second argument is the size of the LR_RAM1 region. In the example below this is set to 16 MB (`0x01000000`).

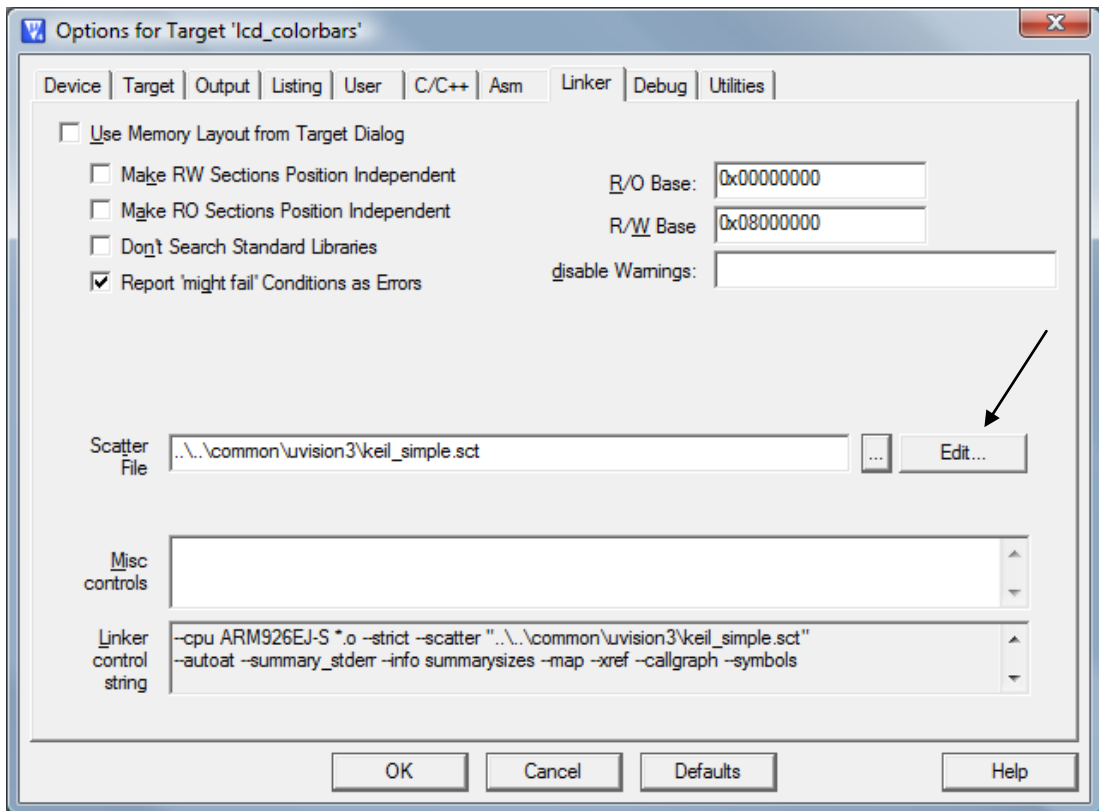

Figure 17 – Linker settings in Keil uVision

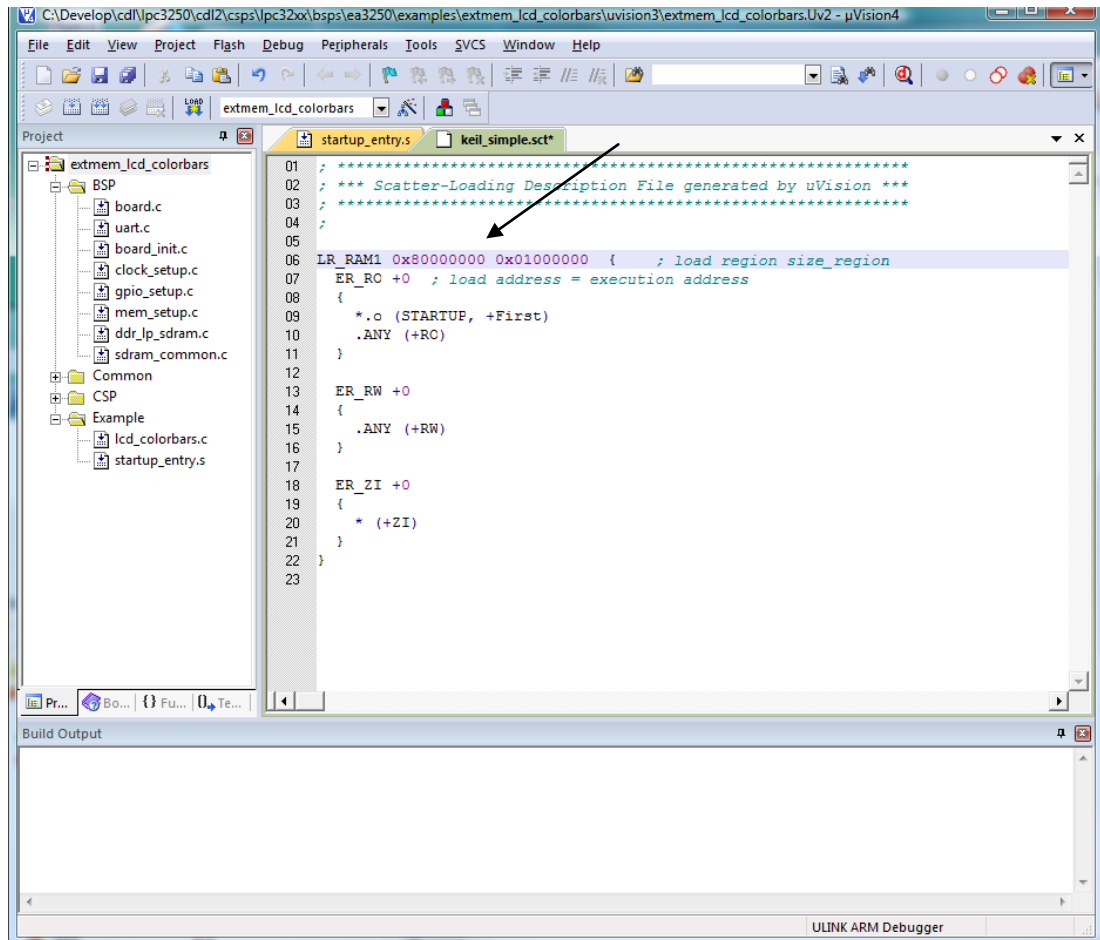
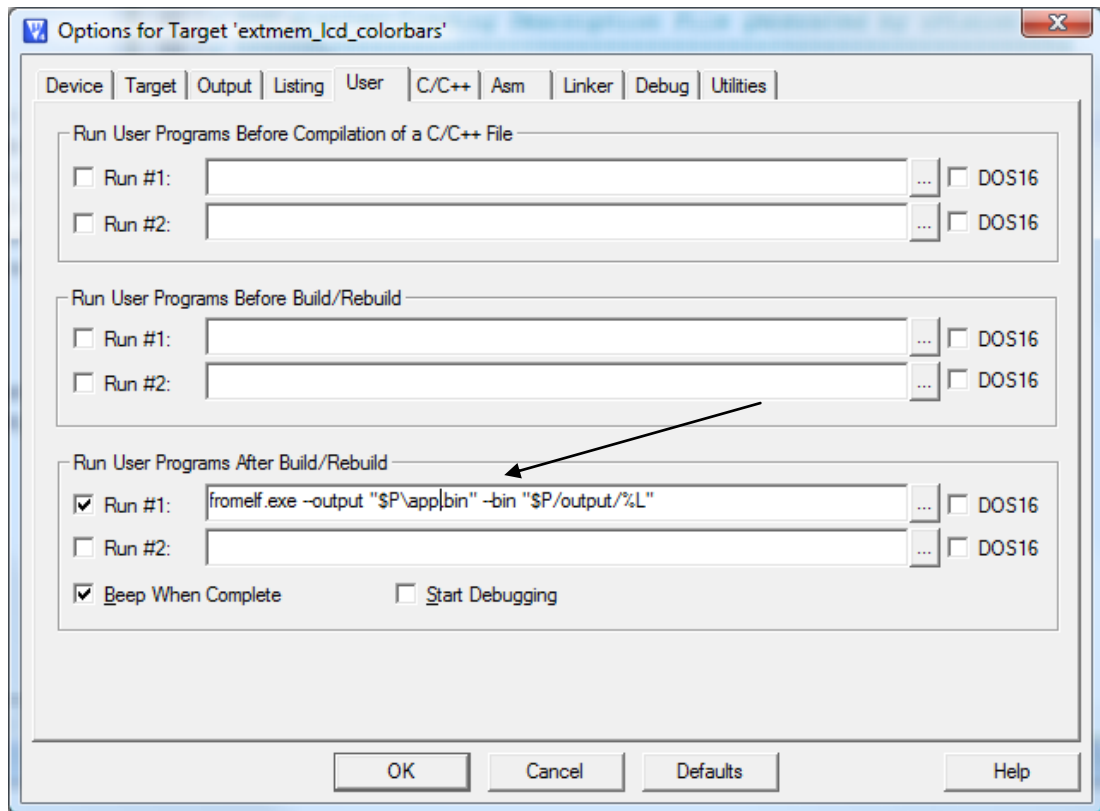

Figure 18 – Scatter file for the sample applications

4. Create a binary file to be stored in NAND flash. This can be done by using the fromelf.exe utility. Go to Project → Options → User. Add the command below to the “Run User Programs After Build/Rebuild”

```
fromelf.exe --output "$P\app.bin" --bin "$P/output/%L"
```



5. Put the binary file (app.bin) on a memory card.
6. Boot into the S1L boot loader and load the application from the memory card, save it to NAND flash and set S1L to automatically load the application at boot.

```
ea3250> load blk app.bin raw 0x80000000
ea3250> nsave
ea3250> aboot flash raw 0x80000000
ea3250> prompt ea3250> 2
```

5.4.3 Service Boot

The LPC3250 bootloader starts by reading the SERVICE_N (GPI_01) input when deciding from which source to boot. If SERVICE_N is low a service boot is performed, which means that it will load code from UART5.

On the QVGA Base Board, GPI_01 is connected to the P2.10 button. Holding down the P2.10 button while resetting the board will force it into service boot.

There are four jumpers on the QVGA Base Board related to the USB serial channel, connected to UART #5 on the LPC3250. See Figure 19 for details about where the jumpers are located. Make sure the 'Service Boot' jumpers are open.

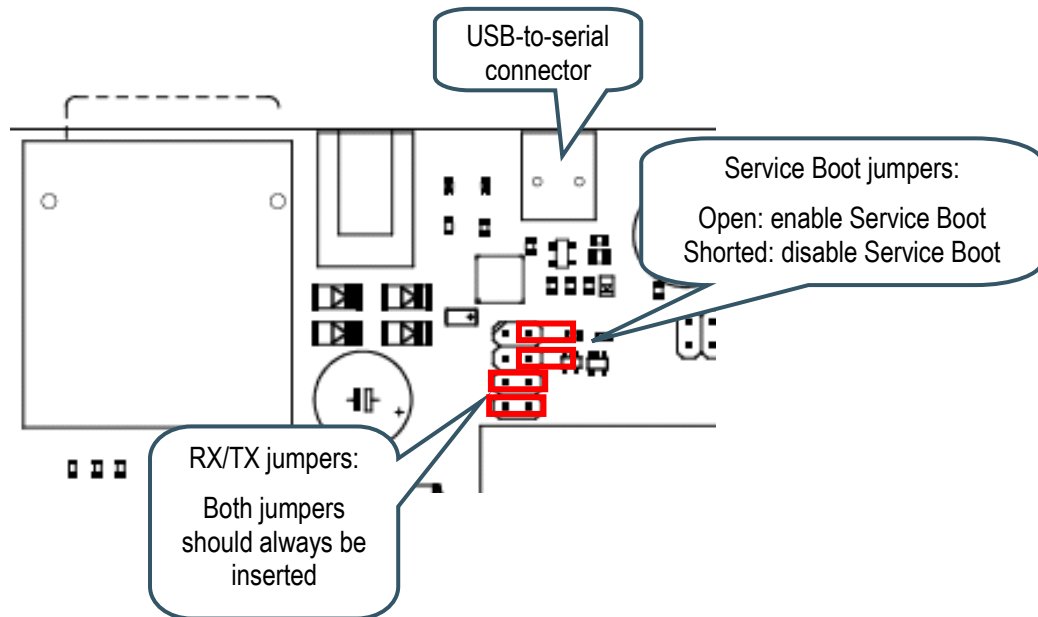

Figure 19 – Jumper Settings for USB/Serial Connection

If they are not, it is possible that a terminal program resets the board and/or enable service boot mode by accident.

In the software bundle with sample applications there is also a Windows application which can be used to transfer a file to the board while it is in service boot mode. The application is available in the `software/cspc/lpc2xx/tools/LPC3250 loader` directory.

1. Start the LPC3250 loader application, see Figure 20.
2. Click the "Browse" button in the Executables - Primary Boot section and select the binary file you would like to transfer to the board.
3. Select COM port and then click the "Enable Terminal Mode" button.
4. Click the "Load bin's / start primary" button.
5. Hold down the P2.10 button on the *QVGA Base Board* and then press the Reset button on the *QVGA Base Board*. When you release the reset button the download will begin.

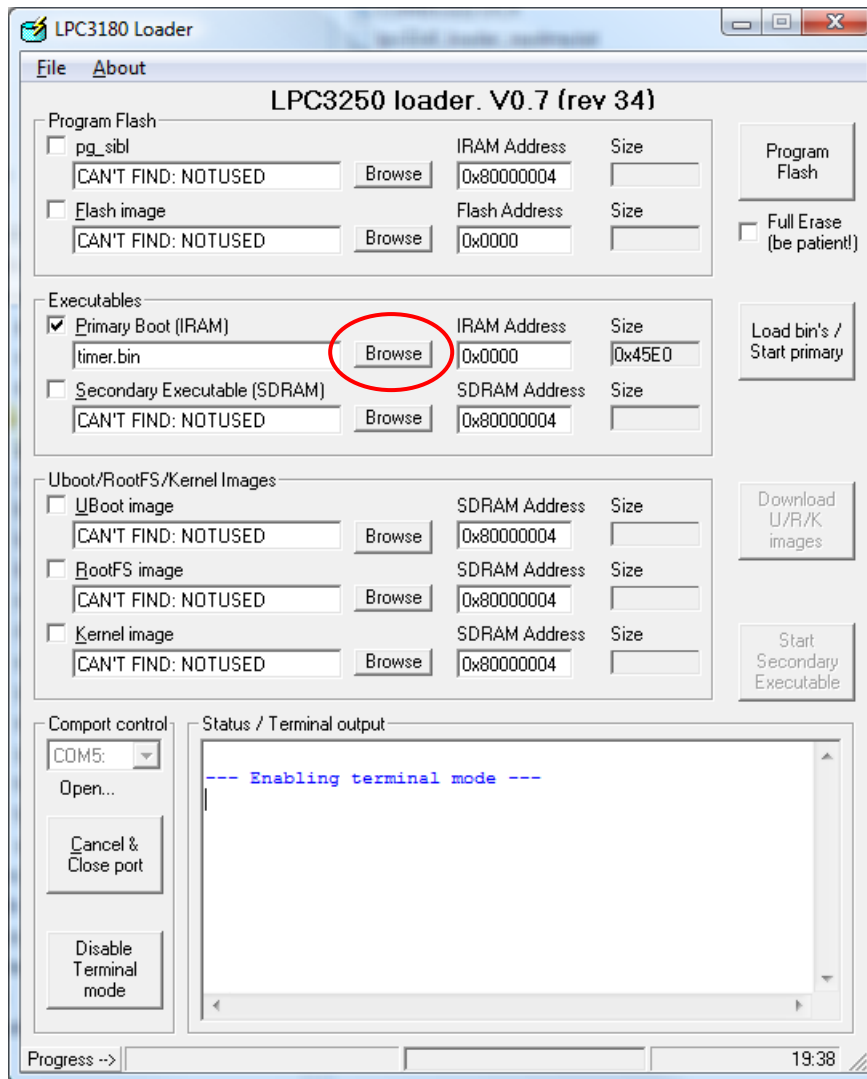

Figure 20 – LPC3250 loader application

6 Further Information

The LPC3250 microcontroller is a complex circuit and there are a number of other documents with more information. The following documents are recommended as a complement to this document.

- [1] NXP LPC3250 Datasheet
<http://ics.nxp.com/products/lpc3000/datasheet/lpc3220.lpc3230.lpc3240.lpc3250.pdf>
- [2] NXP LPC3250 User's Manual
<http://ics.nxp.com/support/documents/microcontrollers/pdf/user.manual.lpc3220.lpc3230.lpc3240.lpc3250.pdf>
- [3] NXP LPC3250 Errata
<http://ics.nxp.com/support/documents/microcontrollers/pdf/errata.lpc3250.pdf>
- [4] ARM926EJ-S Technical Reference Manual. Document identity: DDI0198E
http://infocenter.arm.com/help/topic/com.arm.doc.ddi0198e/DDI0198E_arm926ejs_r0p5_trm.pdf
- [5] ARM Architecture Reference Manual. Document identity: DDI0100E
Book, Second Edition, edited by David Seal, Addison-Wesley: ISBN 0-201-73719-1
Also available in PDF form on the ARM Technical Publications CD
- [6] ARM System Developer's Guide – Designing and Optimizing System Software, by A.N. Sloss, D Symes, C. Wright. Elsevier: ISBN 1-55860-874-5
- [7] Embedded System Design on a Shoestring, by Lewin Edwards.
Newnes: ISBN 0750676094.
- [8] GNU Manuals
<http://www.gnu.org/manual/>
- [9] An Introduction to the GNU Compiler and Linker, by Bill Gatliff
<http://www.billgatliff.com>
- [10] LPC3000 Yahoo Group. A discussion forum dedicated entirely to the NXP LPC3xxx series of microcontrollers.
<http://tech.groups.yahoo.com/group/lpc3000/>
- [11] LPC2000 Yahoo Group. A discussion forum dedicated entirely to the NXP LPC2xxx series of microcontrollers.
<http://tech.groups.yahoo.com/group/lpc2000/>

Note that there can be newer versions of the documents than the ones linked to here. Always check for the latest information / version.